

## Lista Premium 75/200

Drawer cabinets, workbenches and partition material

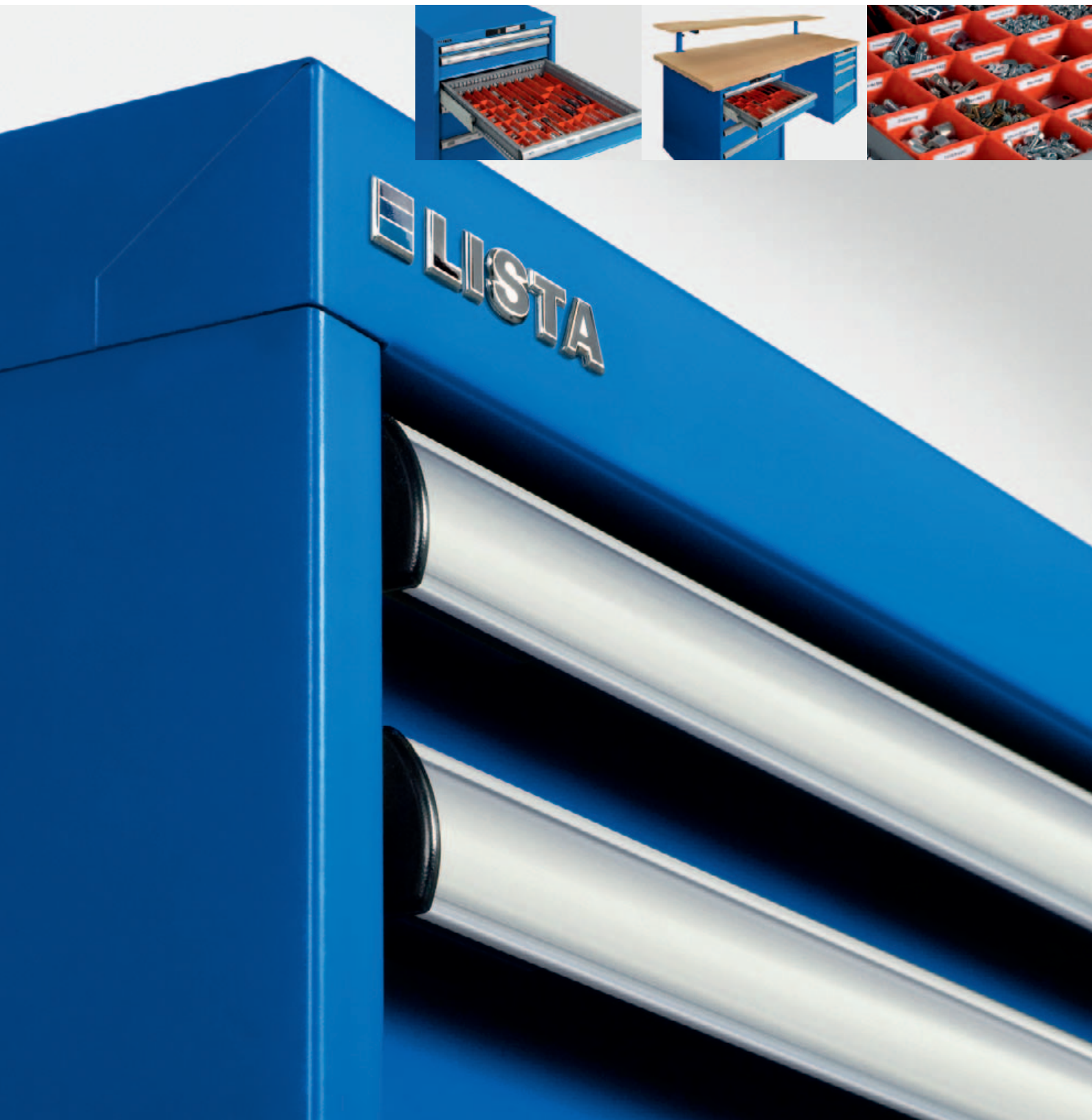



## For professionals, custom-made

### The new product line, Lista Premium

**Lista Premium fulfils every requirement. The freely configurable drawer cabinets and workbenches have the flexibility to be adapted to suit your needs. For example, Lista Premium is available in two new carrying capacity classes: the previously available model for 200 kg per drawer and now the new capacity for 75 kg. And as if those aren't enough innovations: with Lista Premium, all drawers come with full extension.**

#### Lista Premium offers the best

High quality for your specifications: As specialists in your field, you make the highest demands on the quality of your work environment. And from the planning stage to installation you also expect extensive customisation options. With Lista Premium you can be assured of excellent quality. Aside from high quality, you also have the flexibility to configure as you need. There is a choice in the housing size, the size and arrangement of drawers, the colour, the locking system, the individual drawer partition materials and much more.

#### New: Lista Premium 75 and Lista Premium 200

Choice of two carrying capacity classes: The carrying capacity of 200 kg per drawer has been essential for the metal processing industry, some commercial operations and many types of workshops. Hence Lista has been their long-term product of choice. However, in many areas, for example in medicine, the watch industry, laboratories or museums, the goods to be stored are considerably lighter. That is why we now offer new Lista Premium 75 – with all the advantages of Lista Premium 200 but with only 75 kg carrying capacity per drawer to suit your needs.

#### All drawers with full extension

There is one area where Lista Premium does not offer you a choice: All cabinets come exclusively with full drawer extension. This way you can make use of the available space right down to the last square centimetre. The entire drawer contents are easily accessible at any time.

#### Security in capital letters

Our great selection is rounded off by the many options which the locking system makes possible. Whether key, number combination or electronic locking with hand-held transmitter: You have the choice!

**Those who want the best choose without compromise: Lista Premium!**



Lista Premium means: high quality freely configurable drawer cabinets and workbenches.



Lista Premium means: choice of drawer carrying capacity 75 kg or 200 kg.



Lista Premium means: all drawers with full extension!



# Lista Premium 75/200

The new product line, Lista Premium	3
Contents	5
Lista – an overview	6
Quality from A to Z	7
Advice	9
Colours	11

## Drawer cabinets Lista Premium 75/200

Information	13
Drawer cabinets 411 x 572 mm (18 x 27E), partition material (18 x 27E), Lista Script labelling	20
Drawer cabinets 411 x 725 mm (18 x 36E), partition material (18 x 36E), Lista Script labelling	28
Drawer cabinets 564 x 572 mm (27 x 27E), partition material (27 x 27E), Lista Script labelling	36
Drawer cabinets 564 x 725 mm (27 x 36E), partition material (27 x 36E), Lista Script labelling	44
Drawer cabinets 717 x 572 mm (36 x 27E), partition material (36 x 27E), Lista Script labelling	52
Drawer cabinets 717 x 725 mm (36 x 36E), partition material (36 x 36E), Lista Script labelling	60
Drawer cabinets 870 x 725 mm (45 x 36E), partition material (45 x 36E), Lista Script labelling	68
Drawer cabinets 1023 x 572 mm (54 x 27E), partition material (54 x 27E), Lista Script labelling	76
Drawer cabinets 1023 x 725 mm (54 x 36E), partition material (54 x 36E), Lista Script labelling	84
Drawer cabinets 1193 x 725 mm (64 x 36E), partition material (64 x 36E), Lista Script labelling	92
Drawer cabinets 1431 x 725 mm (78 x 36E), partition material (78 x 36E), Lista Script labelling	98

## Workbenches Lista Premium 75/200

Information	104
Workbench tops	112
Workbench substructures	118
Workbench superstructures	138

## Partition material as separate components Lista Premium 75/200

Information	145
Partition material individually (complete sets are covered in the specific sections)	146

## Making Workspace Work

### Lista – an overview



Lista produces drawer systems and furnishing components in five production plants and sells them around the world.

**Time is money. Space is money. As a leading manufacturer of drawer cabinets, Lista brings order and efficiency to the workplace.**

#### **Efficiency at the workplace**

Lista drawer cabinets made of indestructible sheet steel and the matching workbenches are the favourites of industry and commercial operations. Whether in the assembly hall or workshop, in the research laboratory, museum or hospital, in the components warehouse or showroom: Lista excels where tools, stored items and small components need to be available securely, in a space-saving way, clearly arranged and ready at hand.

#### **Investment security**

Those who invest in Lista plan for the future: Our uncompromising quality ensures durability. And the modular nature of our products gives the flexibility of expansion of your existing product configurations as and when your requirements change.

#### **Individual customer support**

You can depend on our expert advice for the custom design of your workplace!



## 10-year guarantee

With Lista Premium you know you have the best

**We use exclusively high-quality materials for our Lista Premium product line. Strength, durability and functional design are the result of decades of experience and innovation.**

### **Lista security can be gauged**

ISO 9001, ISO 14001: The certification of our production processes and services is very important to us. That is why adherence to international standards is a matter of course for us. We only promise what we can deliver. And we deliver more than we promise.

### **10-year guarantee**

You can trust in our quality products. That is why we give our customers a 10-year guarantee (workbench tops 1 year) on the entire Lista Premium product line.

### **Delivery according to your specifications**

You configure your required products including the interior. We build every drawer cabinet and every workbench according to your customised order and deliver it to you immediately after completion.



Certified in compliance with ISO 9001, ISO 14001



10-year guarantee



## Free choice and good advice

We will be happy to show you how

**As a freely configurable product line, Lista Premium can be adapted to meet your individual needs like a properly tailored suit. You can take advantage of our broad range of experience at any time so that everything goes smoothly with this wide selection.**

### User friendly catalogues

We make every effort to ensure that the path from complex task to flexible solution can be travelled smoothly. It begins with this catalogue, which introduces you to our configuration system in a direct, systematic and clearly arranged way. This will enable you to arrive at your individual product through easy steps. Naturally you can always take advantage of our advice. Because with us, the more selection possibilities there are, the more important the good advice!

### Expertise through experience

Our expert consultants belong to the best in the business. This isn't surprising though, because Lista teams have established their high level of expertise over many years. So, with us your needs and expectations are in the best hands. We draw from a deep well of experience and can quickly provide proven practical solutions.

### Wishes granted

Lista embodies modular configurability in steel. Which means simply that, with Lista Premium, you get drawer cabinets and workbenches that fulfil your exact requirements.

### A secure future

Quality lasts. In view of the durability of Lista products, this fact is a major buying point. In addition you can continue to expand your Lista products modularly for many years to come.





## Lista Premium The colours

### Lista Premium is available in 10 standard colours.

The three-digit colour code (e.g. **.010**) is a component of the article number. Always complete the article number of your order with the desired colour code (e.g. 70.701.**010**).



### A further 20 colours are available for a surcharge of 10%.

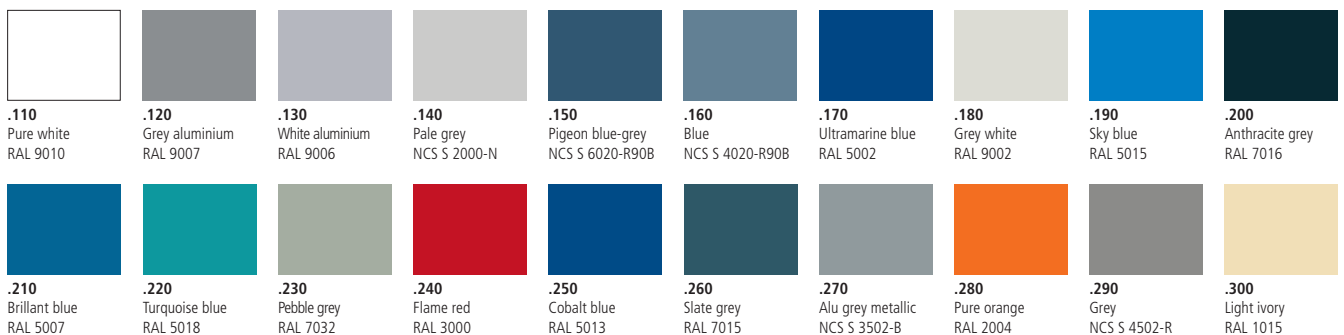

Differences between these colour samples and the original colours may occur for reasons of a printing-technical nature. Other colours are available by request. Please contact us for a price quote!



## Lista Premium drawer cabinets

Those who want the best choice without compromise

Lista Premium drawer cabinets made of sheet steel offer excellent quality from A to Z. The configuration possibilities in size, colour, locking, features and drawer arrangement are virtually unlimited. The new carrying capacity class gives the system even more flexibility. In brief: Lista Premium drawer cabinets offer the best of everything.

### New areas of application

Lista Premium drawer cabinets are available as ever with a carrying capacity of 200 kg per drawer. Now our customers also have the option of a carrying capacity class of 75 kg. This allows us to offer our drawer cabinet for entirely new areas of application. The needs of numerous areas of application are easily fulfilled with 75 kg per drawer.



The versatile drawer partition material allows arrangements which perfectly match the parts to be stored.

### All drawers with full extension

We offer full extension of drawers exclusively with all Lista Premium drawer cabinets. This way access to everything is quick and uncomplicated. The rail castors are made of POM. This allows the same mechanical properties as steel castors yet with smoother running drawers. And a further detail: With our popular labelling system, Lista Script, not only drawers and partition material can be labelled, but now also the housing. Take a closer look at our Lista Premium drawer cabinets on the following pages. You'll see: It's worth it!

## Lista Premium drawer cabinets

### Customised innovation



#### All drawers with full extension

The differential extension, guided without a crossbar, ensures perfectly quiet running – even when the stored materials are very heavy. Moreover, it allows full extension, which is why you also have easy access to parts that have been placed right at the back of the drawer.

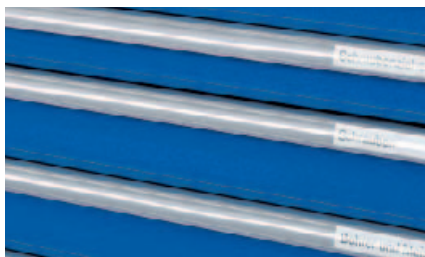

#### Drawer fronts

All drawer handle strips have covers on the sides and are flush with the cabinet housing on the front. This not only has a great appearance, but it also prevents injury.



#### Impact-proof paint finish

Lista Premium 75/200 is available in 10 standard colours and (for a surcharge) in 20 further colours. The environmentally friendly powder coating ensures impact-proof and abrasion resistant surfaces. Drawers are dip-painted and thus have optimal corrosion protection.



#### Central locking system

All drawer cabinets have a patented central locking system that simultaneously locks all drawers.



#### Unmatched: Lista Script

All drawers can be labelled easily, cleanly and systematically using the innovative handle fitted with a transparent viewing window. Even the drawer partition material offers good labelling options. Now you can also label the housing. Further support is available for labelling: the free-of-charge, downloadable software, Lista Script. Information about the matching blank slide-in labels is provided in this catalogue near the respective partition material.

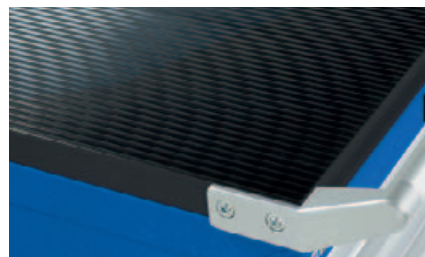

#### Covers

Rubber ribbed mats, as desired with or without retainer top.



#### Safety blocking system

As standard feature, the single-drawer blocking system blocks all other drawers when one drawer is pulled out. This provides reliable protection against the toppling of the cabinet.



#### Mobile cabinets

Our mobile drawer cabinets can feature a retainer top with raised edges on four sides, black ribbed mat as well as two fixed and two steering castors. The steering castors are fitted with a parking brake. Mobile cabinets must be fitted with a drawer safety catch.



#### Base

The base allows the height of the drawer cabinet to be adjusted. Drawer cabinets beginning at a certain size can make use of a pallet base. This allows the cabinet to be moved with a forklift truck.



#### Electronic locking system

With Code Lock, a number combination replaces the key. Due to the battery powered operation, the system is independent of an external power supply. On page 17 you will find a detailed overview of all options which are available for this.



#### Punch out

All body tops are supplied with perforated holes. This allows any cabinets to have a table top or a second cabinet stacked on top of it at a later stage.



#### Drawer safety catch

Four different safety systems for mobile cabinets guarantee safety for mobile cabinets and also for more demanding requirements:

**With safety catch on the right** (per drawer), a catch is mounted under the drawer handle. This kind of drawer safety catch is standard for all mobile cabinets.

For extreme loads in mobile setups (container, trailer or vehicles) we offer three special solutions:

The **drawer safety catch on the right and left** is opened with two hands.

The same applies for the **double safety catch** which offers the advantage that it can be operated with one hand.

**The Lilo safety device** (Lock-in – Lock-out) blocks the drawer in an open or closed state. Drawer extensions have a strip which engages when the drawer is fully extended and blocks the drawer. The same happens when the drawer is closed. This prevents – especially with heavy loads – unintentional closing of the drawer.



#### Partition material

For the sake of orderliness the drawer partition materials have been standardised and thus can be put to use right through the cross section of the Premium assortment. Matching partition material is offered by Lista for each drawer size.



## Lista Premium drawer cabinets

### The locking systems

**The Lista locking systems are put to use where tools, work pieces and stored goods require optimum security.**

#### Key Lock

Standard locking with the central locking system and cylinder lock comes with two keys. The patented lock secures all drawers simultaneously. Only one key type fits per drawer cabinet (separately lockable). Upon request you can also receive one key type for multiple cabinets (one key for all locks). For this feature please choose the body option "Standard lock without cylinder", in addition, the desired equivalent cylinder should be ordered.

#### Code Lock

Here the key is replaced with a number combination. A four-to-six-digit number combination is adequate to open the Lista drawer cabinets. Using a master code, up to 20 individual user codes can be programmed and individually deleted again at any time. This means, in an operation with several people, an individual access system can be created for all cabinets fitted with Code Lock.

Code Lock operates using battery power and is hence independent of the mains supply.

#### Remote Lock and Remote Lock Mobile

Remote Lock and its mobile twin work as an electronic locking system with hand-held radio transmitter. Unlocking is done through a radio signal. You assign access privileges using a programming key. It is also possible using the appropriate components to interlink two or more cabinets. You decide whether the connected cabinets lock individually (2 pin connecting element) or together (4 pin). Remote Lock is connected to the mains supply, while Remote Lock Mobile is fitted with a rechargeable battery.



Standard locking, Key Lock, with key and cylinder lock.



Code Lock, the practical lock with number combination.

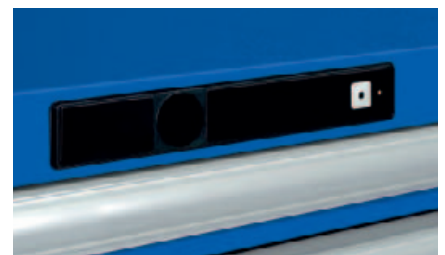

Remote Lock, the programmable, electronic lock with hand-held radio transmitter.

## Listra Premium drawer cabinets

### Selection of the base area

#### The clever measurement system

When selecting a drawer cabinet, first specify the size of the base area. The overview below helps with this selection. The base area determines the useable dimension of the drawer. We indicate both mm measurements as well as Lista units (E) in this catalogue. For the housing, the mm measurements of the base area correspond to width x depth (e.g. 411 x 572 mm); with drawers, to the useable dimension (e.g. 306 x 459 mm). Lista units (E) are a practical representation of the basic grid. They serve to define the clear relationship between housing, drawer and partition material. With the example above, the housing and the drawers that fit in this housing have identical Lista units, namely 18 x 27E, although they have different millimetre measurements. A Lista unit (E) equals 17 mm and is based on the grid division for the drawer partitioning.

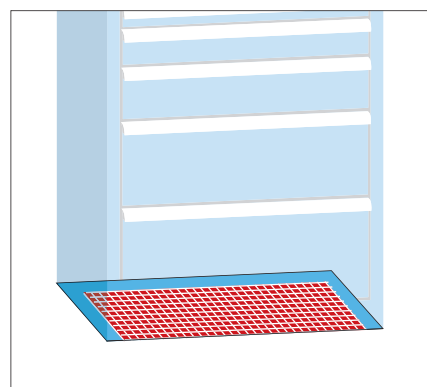
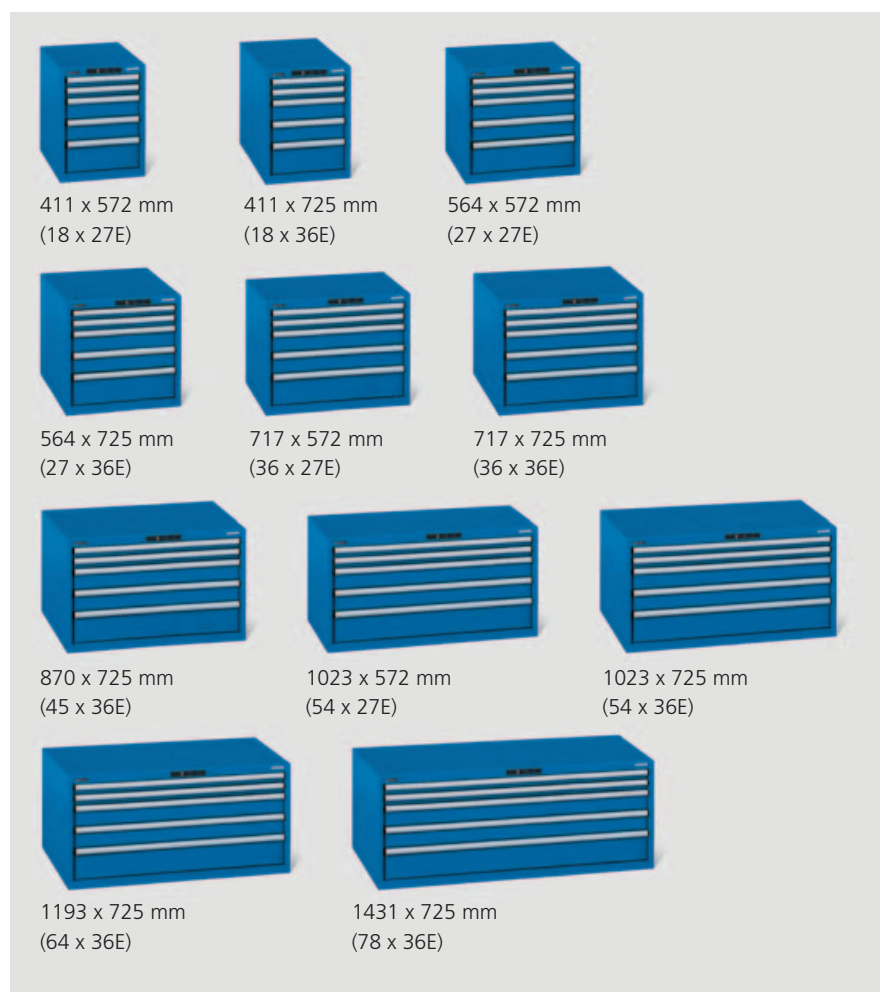
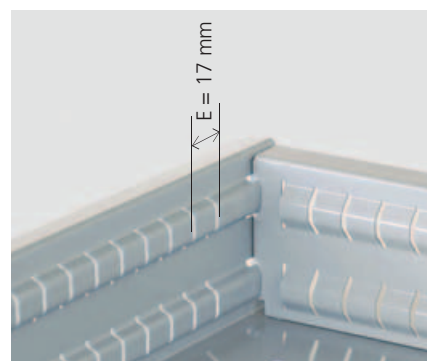

- Useable drawer dimension, based on the grid module E.
- Housing base area, based on the grid module E.

Listra units (E) give housing, drawer and drawer partitions a common point of reference.

# Lista Premium drawer cabinets

## Overview tables

Lista Premium drawer cabinets are available with the following dimensions:

### Overview housing

Width x Depth	411x572 mm	411x725 mm	564x572 mm	564x725 mm	717x572 mm	717x725 mm	870x725 mm	1023x572 mm	1023x725 mm	1193x725 mm	1431x725 mm
Lista units	(18 x 27E)	(18 x 36E)	(27 x 27E)	(27 x 36E)	(36 x 27E)	(36 x 36E)	(45 x 36E)	(54 x 27E)	(54 x 36E)	(64 x 36E)	(78 x 36E)
Height mm	Clear height mm	Clear height mm	Clear height mm	Clear height mm	Clear height mm	Clear height mm	Clear height mm	Clear height mm	Clear height mm	Clear height mm	Clear height mm
283	200	200	200	200							
383	300	300	300	300							
533	450	450	450	450							
650	550	550	550	550							
700	600	600	600	600	600	600	600	600	600	600	600
800			700	700		700					
850			750	750	750	750	750	750	750		
1000	900		900	900	900	900	900	900	900	900	900
1150						1050					
1325						1225					
1450					1350	1350	1350	1350	1350	1225	1225
1625						1525				1350	1350

### Overview drawers (useable dimensions)

Width x Depth	306x459 mm	306x612 mm	459x459 mm	459x612 mm	612x459 mm	612x612 mm	765x612 mm	918x459 mm	918x612 mm	1088x612 mm	1326x612 mm
Lista units	(18 x 27E)	(18 x 36E)	(27 x 27E)	(27 x 36E)	(36 x 27E)	(36 x 36E)	(45 x 36E)	(54 x 27E)	(54 x 36E)	(64 x 36E)	(78 x 36E)
Front height mm	Carrying capacity kg	Carrying capacity kg	Carrying capacity kg	Carrying capacity kg	Carrying capacity kg	Carrying capacity kg	Carrying capacity kg	Carrying capacity kg	Carrying capacity kg	Carrying capacity kg	Carrying capacity kg
50 (29)	75	75	75	75	75	75	75	75	75		
75 (54)	75	75	75/200	75/200	75/200	75/200	200	200	200	200	200
100 (79)	75	75	75/200	75/200	75/200	75/200	200	200	200	200	200
125 (104)			75/200	75/200	75/200	75/200	200	200	200	200	200
150 (129)	75	75	75/200	75/200	75/200	75/200	200	200	200	200	200
200 (179)	75	75	75/200	75/200	75/200	75/200	200	200	200	200	200
250 (229)			75/200	75/200	75/200	75/200	200	200	200	200	200
300 (279)	75	75	75/200	75/200	75/200	75/200	200	200	200	200	200

Values in parentheses = useable drawer height

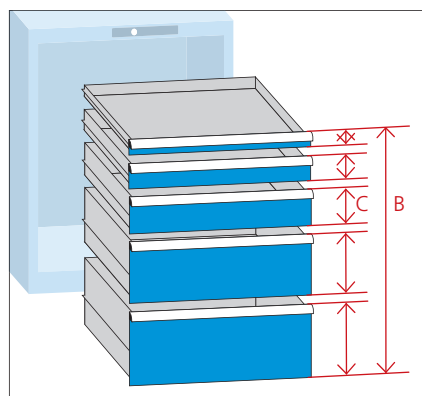
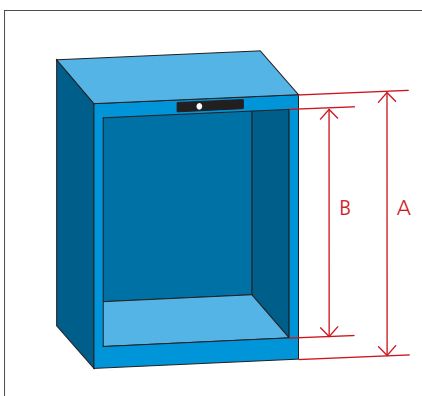

A Housing height  
B Clear height  
C Front height

## Lista Premium drawer cabinets

Width 411 mm, depth 572 mm (18 x 27E)

### Configuration examples



## Listra Premium drawer cabinets

Width 411 mm, depth 572 mm (18 x 27E)

**Configuration instructions: this is how to put your drawer cabinet together.**

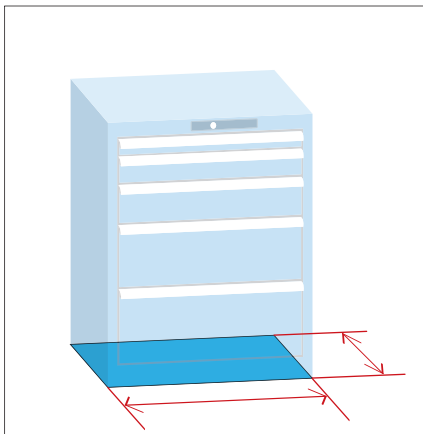

### 1. Selection of the cabinet base area

The first step is the selection of the cabinet base area. It can be indicated in millimetres (width x depth) or Lista units (E x E). The measurements E x E indicate which drawers match which housings.

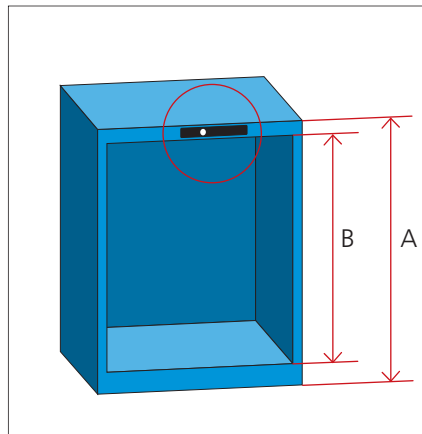

### 2. Selection of housing and locking system

After selecting a base area you can specify the housing. Different heights are available for every floor plan. The selection of housing always includes the choice of the desired locking system and colour.

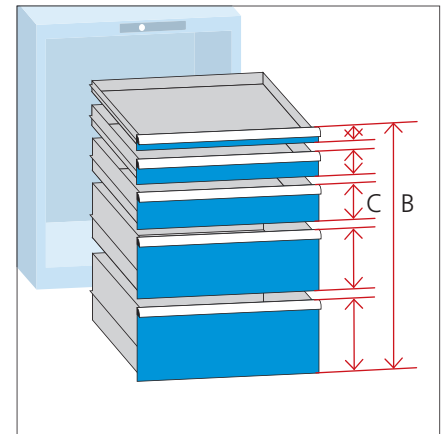

### 3. Selection of drawers

Determine the front height, carrying capacity, and colour of the drawers. The sum total of the front heights C must correspond to the clear height B (refer to figure in point 2). Please also select the type of safety catch.



### 4. Selection of accessories

The drawer cabinet can be combined with hinged door, plain shelves and pull-out shelves. Further housing accessories (cover, base, wheels and push handle for mobile cabinets) are also available. Mobile cabinets must be fitted with a drawer safety catch.

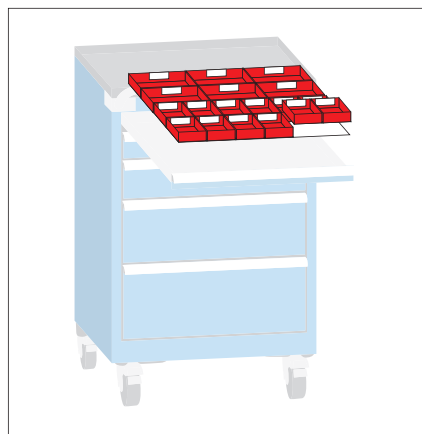

### 5. Selection of partition material

Partition material for drawers is usually ordered as a set. The available selection is large. Please note: The partition material must match the drawer height and useable dimension.

### 6. Determination of the price

The price of the drawer cabinet corresponds to the sum of all selected elements in the corresponding configuration.

# Drawer cabinets Lista Premium

## Width 411 mm, depth 572 mm (18 x 27E)

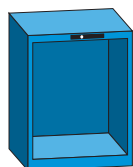

### Housing

Height mm	Clear height mm	Key Lock	Code Lock	Remote Lock	Remote Lock Mobile	Lock without cylinder
283	200	<b>71.059.XXX</b> GBP 124.00	<b>71.118.XXX</b> GBP 164.00	<b>71.177.XXX</b> GBP 279.00		<b>71.000.XXX</b> GBP 115.00
383	300	<b>71.060.XXX</b> GBP 132.00	<b>71.119.XXX</b> GBP 172.00	<b>71.178.XXX</b> GBP 287.00		<b>71.001.XXX</b> GBP 123.00
533	450	<b>71.061.XXX</b> GBP 143.00	<b>71.120.XXX</b> GBP 183.00	<b>71.179.XXX</b> GBP 298.00	<b>71.236.XXX</b> GBP 368.00	<b>71.002.XXX</b> GBP 134.00
650	550	<b>71.062.XXX</b> GBP 159.00	<b>71.121.XXX</b> GBP 199.00	<b>71.180.XXX</b> GBP 314.00	<b>71.237.XXX</b> GBP 384.00	<b>71.003.XXX</b> GBP 150.00
700	600	<b>71.063.XXX</b> GBP 164.00	<b>71.122.XXX</b> GBP 204.00	<b>71.181.XXX</b> GBP 319.00	<b>71.238.XXX</b> GBP 389.00	<b>71.004.XXX</b> GBP 155.00
1000	900	<b>71.064.XXX</b> GBP 193.00	<b>71.123.XXX</b> GBP 233.00	<b>71.182.XXX</b> GBP 348.00	<b>71.239.XXX</b> GBP 418.00	<b>71.005.XXX</b> GBP 184.00

### Accessories Remote Lock

Designation	
Hand-held radio transmitter	<b>74.092.000</b> GBP 23.00
Programming key	<b>74.093.000</b> GBP 33.00
Adapter	<b>74.094.000</b> GBP 33.00
Extension unit 2-pole, 1850 mm	<b>74.098.000</b> GBP 23.00
Extension unit 4-pole, 1850 mm	<b>74.099.000</b> GBP 25.00

### Accessories drawer cabinet without cylinder

Designation	
Cylinder 2C 1 simultaneously lockable	<b>222.377.000</b> GBP 11.00
Cylinder 2C 2 simultaneously lockable	<b>222.378.000</b> GBP 11.00
Cylinder 2C 3 simultaneously lockable	<b>222.379.000</b> GBP 11.00
Cylinder 2C 4 simultaneously lockable	<b>222.380.000</b> GBP 11.00
Cylinder 2C 5 simultaneously lockable	<b>222.381.000</b> GBP 11.00
Cylinder 2C 6 simultaneously lockable	<b>222.382.000</b> GBP 11.00
Cylinder 2C _ simultaneously lockable	<b>222.383.000</b> GBP 12.00
Cylinder main locking system	<b>222.384.000</b> GBP 16.00

### The Lista housing locks

#### Key Lock

Standard closure with central locking system and Lista cylinder lock, individual lock, with 2 keys.

#### Code Lock

Electronic locking system, a number combination replaces the key. Programmable user codes allow a flexible locking system to be created. Battery powered.

#### Remote Lock

Electronic locking system with hand-held radio transmitter (unlocking through radio pulse). A programming key grants access and authorisation. Interlinking of cabinets possible using interlink elements. Connects to main supply (adapter necessary). Please note: hand-held radio transmitter, programming key and adapter not included. Can be ordered optionally if required.

#### Remote Lock Mobile

Same functionality as Remote Lock, but with rechargeable battery (requirement for mobile model). Hand-held radio transmitter and programming key not included. Can be ordered optionally if required.

#### Lock without cylinder

Lock to be included in complete locking systems (simultaneously or main locking systems). For cylinders ordered with predefined lock numbers (2C 1 – 2C 6) or a freely defined number (2C \_). Should a cylinder not be ordered, the housing will be supplied with a lock cover.

For further information on locking systems see page 17.

### The Lista standard colours (without extra charge)

Please complete the last 3 digits of your product code (.XXX) with the desired colour code.

<b>.010</b>	<b>.020</b>	<b>.030</b>	<b>.040</b>	<b>.050</b>	<b>.060</b>	<b>.070</b>	<b>.080</b>	<b>.090</b>	<b>.100</b>
Light blue RAL 5012	Light grey RAL 7035	Reseda green RAL 6011	Capri blue RAL 5019	Grey metallic NCS S 6502-B	Black NCS S 9000-N	Ruby red RAL 3003	Pigeon grey NCS S 4502-B	Gentian blue RAL 5010	Signal blue RAL 5005

# Drawers Lista Premium

Useable drawer dimension 306 x 459 mm (18 x 27E)

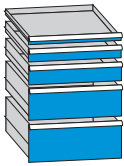

## Drawers 75 kg

Front height mm (useable height)	Standard	Safety catch on the right	Safety catch on the right and left	Double safety catch
50 (29)	<b>72.000.XXX</b> GBP 51.00	<b>72.110.XXX</b> GBP 52.00	<b>72.220.XXX</b> GBP 53.00	<b>72.330.XXX</b> GBP 71.00
75 (54)	<b>72.001.XXX</b> GBP 53.00	<b>72.111.XXX</b> GBP 54.00	<b>72.221.XXX</b> GBP 55.00	<b>72.331.XXX</b> GBP 73.00
100 (79)	<b>72.002.XXX</b> GBP 55.00	<b>72.112.XXX</b> GBP 56.00	<b>72.222.XXX</b> GBP 57.00	<b>72.332.XXX</b> GBP 75.00
150 (129)	<b>72.003.XXX</b> GBP 58.00	<b>72.113.XXX</b> GBP 59.00	<b>72.223.XXX</b> GBP 60.00	<b>72.333.XXX</b> GBP 78.00
200 (179)	<b>72.004.XXX</b> GBP 66.00	<b>72.114.XXX</b> GBP 67.00	<b>72.224.XXX</b> GBP 68.00	<b>72.334.XXX</b> GBP 86.00
300 (279)	<b>72.005.XXX</b> GBP 77.00	<b>72.115.XXX</b> GBP 78.00	<b>72.225.XXX</b> GBP 79.00	<b>72.335.XXX</b> GBP 97.00

## The Lista drawer safety catch

### Standard

Standard model without drawer-locking facility.

### Safety catch on the right

Mobile cabinets must be fitted with a drawer safety catch. Prevents unintended opening of drawers even when the cabinet is not locked.

### Safety catch on the right and left as well as double safety catch

Increased safety for use on mobile equipment. Safety catch right and left, operated with both hands. Double catch centrally operated with one hand.

## The Lista standard colours (without extra charge)

Please complete the last 3 digits of your product code (.XXX) with the desired colour code.

<b>.010</b>	<b>.020</b>	<b>.030</b>	<b>.040</b>	<b>.050</b>	<b>.060</b>	<b>.070</b>	<b>.080</b>	<b>.090</b>	<b>.100</b>
Light blue RAL 5012	Light grey RAL 7035	Reseda green RAL 6011	Capri blue RAL 5019	Grey metallic NCS S 6502-B	Black NCS S 9000-N	Ruby red RAL 3003	Pigeon grey NCS S 4502-B	Gentian blue RAL 5010	Signal blue RAL 5005

# Hinged doors and housing accessories Lista Premium

## Width 411 mm, depth 572 mm (18 x 27E)



### Door mounted on the right

As front closure for the pull-out and adjustable shelves installed in the housing under the drawers. The sum total of the door front height together with all drawer front heights must equal the height clearance of the cabinet housing. Model: made of sheet steel. Colour: see colour chart page 11.

Height mm	Description	
450	With cylinder lock	<b>74.000.XXX</b> GBP 64.00
600	With cylinder lock	<b>74.001.XXX</b> GBP 69.00

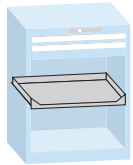

### Pull-out shelf, load capacity 75 kg

The 25-mm divisions in the vertical supports of the cabinet housing allow the pull-out shelves to be mounted in the same cabinet housing in any order. Model: made of sheet steel. Colour: grey NCS S 4502-B.

Height mm	
100	<b>74.004.000</b> GBP 60.00



### Adjustable shelf, load capacity 75 kg

The 25-mm divisions in the vertical supports of the cabinet housing allow the shelves to be mounted in the same cabinet housing in any order. Model: made of sheet steel. Colour: grey NCS S 4502-B.

Height mm	
75	<b>74.005.000</b> GBP 25.00

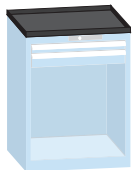

### Cover

Available with or without raised edging. Colour: black.

Designation	
Ribbed mat, single, black	<b>74.012.000</b> GBP 12.00
Retainer top with raised edges, 3-sided, incl. ribbed mat (black)	<b>74.023.000</b> GBP 33.00



### Base

To adjust the height. Colour: black.

Designation	
Housing base, black, height 50 mm	<b>74.045.000</b> GBP 33.00
Housing base, black, height 100 mm	<b>74.046.000</b> GBP 35.00



### Mobile model

Raised edging, 4-sided, incl. ribbed mat (black), 2 swivel castors with brakes, 2 fixed castors, max. load capacity 400kg, with either nylon or rubber wheels, 1 push handle.

Designation	
Retainer top with raised edges, 4-sided, incl. ribbed mat (black) and push handle	<b>74.034.000</b> GBP 64.00
Pair of castor supports, with nylon roller set ø 100 mm	<b>74.071.000</b> GBP 62.00
Pair of castor supports, with rubber roller set ø 100 mm	<b>74.072.000</b> GBP 82.00

# Partition material Lista Premium

Useable drawer dimension 306 x 459 mm (18 x 27E)

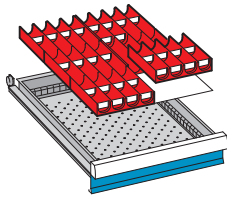

## Troughs

### For front height mm

50	<b>80.377.000</b> GBP 17.80
----	--------------------------------

6 trough-shaped parts: 4 grooves  
30 trough dividers: 4 grooves

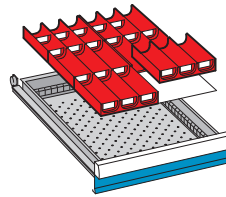

## Troughs

### For front height mm

50	<b>80.378.000</b> GBP 15.00
----	--------------------------------

6 trough-shaped parts: 3 grooves  
20 trough dividers: 3 grooves

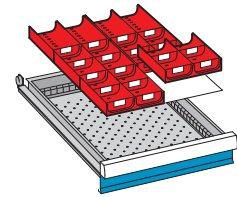

## Troughs

### For front height mm

50	<b>80.379.000</b> GBP 14.50
----	--------------------------------

6 trough-shaped parts: 2 grooves  
20 trough dividers: 2 grooves

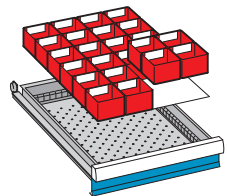

## Plastic boxes

### For front height mm

50	<b>80.372.000</b> GBP 17.50
75	<b>80.414.000</b> GBP 21.30

24 plastic boxes: 75 x 75 mm

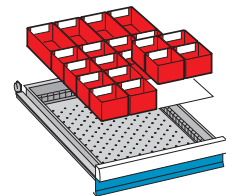

## Plastic boxes

### For front height mm

50	<b>80.368.000</b> GBP 15.30
75	<b>80.412.000</b> GBP 19.00

16 plastic boxes: 75 x 75 mm  
4 plastic boxes: 75 x 150 mm

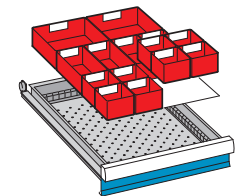

## Plastic boxes

### For front height mm

50	<b>80.370.000</b> GBP 12.50
75	<b>80.413.000</b> GBP 15.50

8 plastic boxes: 75 x 75 mm  
4 plastic boxes: 75 x 150 mm  
2 plastic boxes: 150 x 150 mm

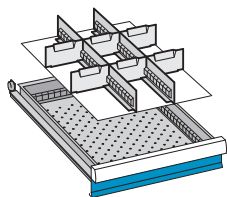

## Dividers

### For front height mm

50	<b>80.639.000</b> GBP 8.00
75	<b>80.640.000</b> GBP 9.30
100	<b>80.641.000</b> GBP 12.00
150	<b>80.642.000</b> GBP 14.50

2 slotted partitions: 27E  
6 dividers: 6E

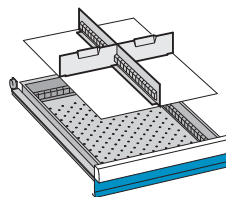

## Dividers

### For front height mm

50	<b>80.643.000</b> GBP 3.90
75	<b>80.644.000</b> GBP 4.30
100	<b>80.645.000</b> GBP 5.80
150	<b>80.646.000</b> GBP 6.80
200	<b>80.647.000</b> GBP 8.30
300	<b>80.648.000</b> GBP 11.50

1 slotted partition: 27E  
2 dividers: 9E

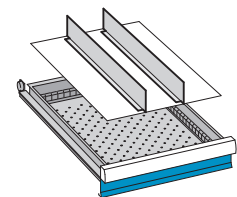

## Dividers

### For front height mm

75	<b>100.315.000</b> GBP 3.60
100, 125	<b>100.130.000</b> GBP 4.50
150	<b>100.131.000</b> GBP 5.80
200	<b>100.132.000</b> GBP 7.30

2 plain partitions: 27E

## Partition material Lista Premium

Useable drawer dimension 306 x 459 mm (18 x 27E)

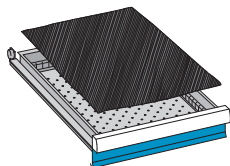

### Anti-slide mat

#### Designation

Anti-slide mat anthracite	<b>119.001.000</b> GBP 2.50
---------------------------	--------------------------------

Coating: special soft PVC foam.  
Extremely hardwearing and tear-proof.

### Lista Script labels for partition material

Label size mm	Used for	Number	
47 x 18	Plastic boxes, clip-on label holders	2 sheets (A4), 52 labels each	<b>18.785.000</b> GBP 1.60
47 x 12	Plastic boxes, clip-on label holders	2 sheets (A4), 76 labels each	<b>18.786.000</b> GBP 1.60
27 x 12	Plastic boxes, clip-on label holders	2 sheets (A4), 133 labels each	<b>18.787.000</b> GBP 1.60

### Lista Script labels for cabinet labelling

Label size mm	Used for	Number	
210 x 22 / 70 x 22	Drawer handle, drawer cabinet	5 sheets (A4), 10/30 labels each	<b>18.784.000</b> GBP 2.60

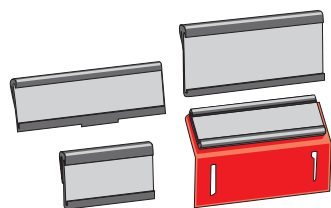

### Clip-on label holders for partition material

Label size mm	Used for	Number	
27 x 12	Trough dividers, dividers, etc.	20 clip-on label holder, 266 labels	<b>134.029.000</b> GBP 7.30
47 x 12	Plastic boxes	20 label holders red	<b>134.034.000</b> GBP 6.80
47 x 12	Dividers, etc.	20 clip-on label holder, 152 labels	<b>134.049.000</b> GBP 7.30
47 x 18	Dividers, etc.	20 clip-on label holder, 104 labels	<b>134.052.000</b> GBP 7.30



## Lista Premium drawer cabinets

Width 411 mm, depth 725 mm (18 x 36E)

### Configuration examples



## Listra Premium drawer cabinets

Width 411 mm, depth 725 mm (18 x 36E)

**Configuration instructions: this is how to put your drawer cabinet together.**

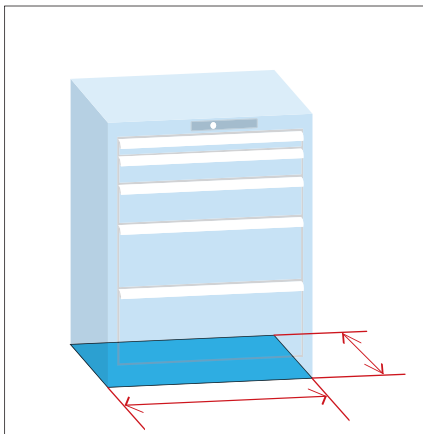

### 1. Selection of the cabinet base area

The first step is the selection of the cabinet base area. It can be indicated in millimetres (width x depth) or Lista units (E x E). The measurements E x E indicate which drawers match which housings.

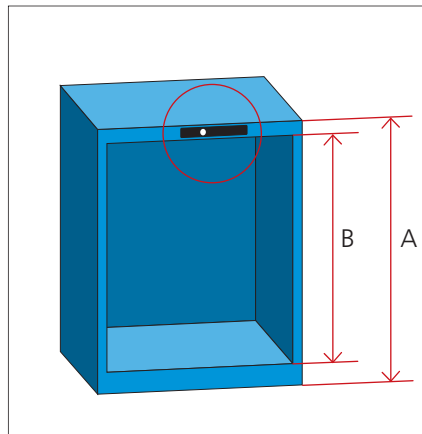

### 2. Selection of housing and locking system

After selecting a base area you can specify the housing. Different heights are available for every floor plan. The selection of housing always includes the choice of the desired locking system and colour.

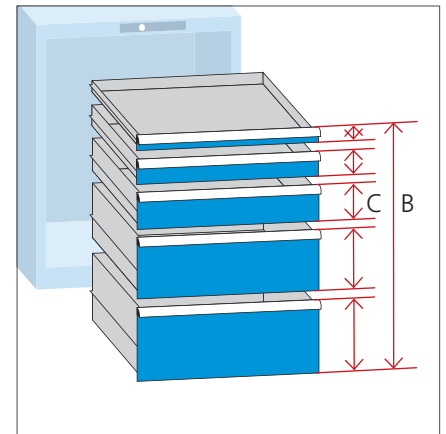

### 3. Selection of drawers

Determine the front height, carrying capacity, and colour of the drawers. The sum total of the front heights C must correspond to the clear height B (refer to figure in point 2). Please also select the type of safety catch.



### 4. Selection of accessories

The drawer cabinet can be combined with hinged door, plain shelves and pull-out shelves. Further housing accessories (cover, base, wheels and push handle for mobile cabinets) are also available. Mobile cabinets must be fitted with a drawer safety catch.

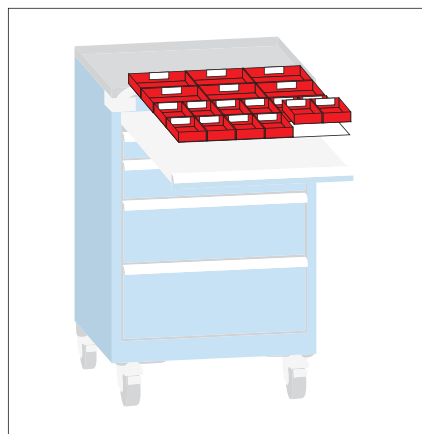

### 5. Selection of partition material

Partition material for drawers is usually ordered as a set. The available selection is large. Please note: The partition material must match the drawer height and useable dimension.

### 6. Determination of the price

The price of the drawer cabinet corresponds to the sum of all selected elements in the corresponding configuration.

# Drawer cabinets Lista Premium

## Width 411 mm, depth 725 mm (18 x 36E)

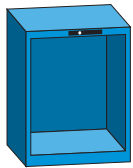

### Housing

Height mm	Clear height mm	Key Lock	Code Lock	Remote Lock	Remote Lock Mobile	Lock without cylinder
283	200	<b>71.065.XXX</b> GBP 136.00	<b>71.124.XXX</b> GBP 176.00	<b>71.183.XXX</b> GBP 291.00		<b>71.006.XXX</b> GBP 127.00
383	300	<b>71.066.XXX</b> GBP 146.00	<b>71.125.XXX</b> GBP 186.00	<b>71.184.XXX</b> GBP 301.00		<b>71.007.XXX</b> GBP 137.00
533	450	<b>71.067.XXX</b> GBP 164.00	<b>71.126.XXX</b> GBP 204.00	<b>71.185.XXX</b> GBP 319.00	<b>71.240.XXX</b> GBP 389.00	<b>71.008.XXX</b> GBP 155.00
650	550	<b>71.068.XXX</b> GBP 180.00	<b>71.127.XXX</b> GBP 220.00	<b>71.186.XXX</b> GBP 335.00	<b>71.241.XXX</b> GBP 405.00	<b>71.009.XXX</b> GBP 171.00
700	600	<b>71.069.XXX</b> GBP 185.00	<b>71.128.XXX</b> GBP 225.00	<b>71.187.XXX</b> GBP 340.00	<b>71.242.XXX</b> GBP 410.00	<b>71.010.XXX</b> GBP 176.00

### Accessories Remote Lock

Designation	
Hand-held radio transmitter	<b>74.092.000</b> GBP 23.00
Programming key	<b>74.093.000</b> GBP 33.00
Adapter	<b>74.094.000</b> GBP 33.00
Extension unit 2-pole, 1850 mm	<b>74.098.000</b> GBP 23.00
Extension unit 4-pole, 1850 mm	<b>74.099.000</b> GBP 25.00

### Accessories drawer cabinet without cylinder

Designation	
Cylinder 2C 1 simultaneously lockable	<b>222.377.000</b> GBP 11.00
Cylinder 2C 2 simultaneously lockable	<b>222.378.000</b> GBP 11.00
Cylinder 2C 3 simultaneously lockable	<b>222.379.000</b> GBP 11.00
Cylinder 2C 4 simultaneously lockable	<b>222.380.000</b> GBP 11.00
Cylinder 2C 5 simultaneously lockable	<b>222.381.000</b> GBP 11.00
Cylinder 2C 6 simultaneously lockable	<b>222.382.000</b> GBP 11.00
Cylinder 2C _ simultaneously lockable	<b>222.383.000</b> GBP 12.00
Cylinder main locking system	<b>222.384.000</b> GBP 16.00

### The Lista housing locks

#### Key Lock

Standard closure with central locking system and Lista cylinder lock, individual lock, with 2 keys.

#### Code Lock

Electronic locking system, a number combination replaces the key. Programmable user codes allow a flexible locking system to be created. Battery powered.

#### Remote Lock

Electronic locking system with hand-held radio transmitter (unlocking through radio pulse). A programming key grants access and authorisation. Interlinking of cabinets possible using interlink elements. Connects to main supply (adapter necessary). Please note: hand-held radio transmitter, programming key and adapter not included. Can be ordered optionally if required.

#### Remote Lock Mobile

Same functionality as Remote Lock, but with rechargeable battery (requirement for mobile model). Hand-held radio transmitter and programming key not included. Can be ordered optionally if required.

#### Lock without cylinder

Lock to be included in complete locking systems (simultaneously or main locking systems). For cylinders ordered with predefined lock numbers (2C 1 – 2C 6) or a freely defined number (2C \_). Should a cylinder not be ordered, the housing will be supplied with a lock cover.

For further information on locking systems see page 17.

### The Lista standard colours (without extra charge)

Please complete the last 3 digits of your product code (.XXX) with the desired colour code.

<b>.010</b>	<b>.020</b>	<b>.030</b>	<b>.040</b>	<b>.050</b>	<b>.060</b>	<b>.070</b>	<b>.080</b>	<b>.090</b>	<b>.100</b>
Light blue RAL 5012	Light grey RAL 7035	Reseda green RAL 6011	Capri blue RAL 5019	Grey metallic NCS S 6502-B	Black NCS S 9000-N	Ruby red RAL 3003	Pigeon grey NCS S 4502-B	Gentian blue RAL 5010	Signal blue RAL 5005

# Drawers Lista Premium

Useable drawer dimension 306 x 612 mm (18 x 36E)

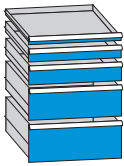

## Drawers 75 kg

Front height mm (useable height)	Standard	Safety catch on the right	Safety catch on the right and left	Double safety catch
50 (29)	<b>72.006.XXX</b> GBP 57.00	<b>72.116.XXX</b> GBP 58.00	<b>72.226.XXX</b> GBP 59.00	<b>72.336.XXX</b> GBP 77.00
75 (54)	<b>72.007.XXX</b> GBP 60.00	<b>72.117.XXX</b> GBP 61.00	<b>72.227.XXX</b> GBP 62.00	<b>72.337.XXX</b> GBP 80.00
100 (79)	<b>72.008.XXX</b> GBP 62.00	<b>72.118.XXX</b> GBP 63.00	<b>72.228.XXX</b> GBP 64.00	<b>72.338.XXX</b> GBP 82.00
150 (129)	<b>72.009.XXX</b> GBP 67.00	<b>72.119.XXX</b> GBP 68.00	<b>72.229.XXX</b> GBP 69.00	<b>72.339.XXX</b> GBP 87.00
200 (179)	<b>72.010.XXX</b> GBP 71.00	<b>72.120.XXX</b> GBP 72.00	<b>72.230.XXX</b> GBP 73.00	<b>72.340.XXX</b> GBP 91.00
300 (279)	<b>72.011.XXX</b> GBP 83.00	<b>72.121.XXX</b> GBP 84.00	<b>72.231.XXX</b> GBP 85.00	<b>72.341.XXX</b> GBP 103.00

## The Lista drawer safety catch

### Standard

Standard model without drawer-locking facility.

### Safety catch on the right

Mobile cabinets must be fitted with a drawer safety catch. Prevents unintended opening of drawers even when the cabinet is not locked.

### Safety catch on the right and left as well as double safety catch

Increased safety for use on mobile equipment. Safety catch right and left, operated with both hands. Double catch centrally operated with one hand.

## The Lista standard colours (without extra charge)

Please complete the last 3 digits of your product code (.**XXX**) with the desired colour code.

<b>.010</b>	<b>.020</b>	<b>.030</b>	<b>.040</b>	<b>.050</b>	<b>.060</b>	<b>.070</b>	<b>.080</b>	<b>.090</b>	<b>.100</b>
Light blue RAL 5012	Light grey RAL 7035	Reseda green RAL 6011	Capri blue RAL 5019	Grey metallic NCS S 6502-B	Black NCS S 9000-N	Ruby red RAL 3003	Pigeon grey NCS S 4502-B	Gentian blue RAL 5010	Signal blue RAL 5005

# Hinged doors and housing accessories Lista Premium

## Width 411 mm, depth 725 mm (18 x 36E)



### Door mounted on the right

As front closure for the pull-out and adjustable shelves installed in the housing under the drawers. The sum total of the door front height together with all drawer front heights must equal the height clearance of the cabinet housing. Model: made of sheet steel. Colour: see colour chart page 11.

Height mm	Description	
450	With cylinder lock	<b>74.000.XXX</b> GBP 64.00
600	With cylinder lock	<b>74.001.XXX</b> GBP 69.00

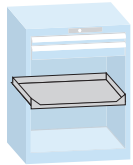

### Pull-out shelf, load capacity 75 kg

The 25-mm divisions in the vertical supports of the cabinet housing allow the pull-out shelves to be mounted in the same cabinet housing in any order. Model: made of sheet steel. Colour: grey NCS S 4502-B.

Height mm	
100	<b>74.006.000</b> GBP 65.00



### Adjustable shelf, load capacity 75 kg

The 25-mm divisions in the vertical supports of the cabinet housing allow the shelves to be mounted in the same cabinet housing in any order. Model: made of sheet steel. Colour: grey NCS S 4502-B.

Height mm	
75	<b>74.007.000</b> GBP 28.00

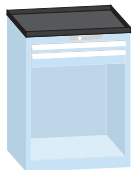

### Cover

Available with or without raised edging. Colour: black.

Designation	
Ribbed mat, single, black	<b>74.013.000</b> GBP 14.00
Retainer top with raised edges, 3-sided, incl. ribbed mat (black)	<b>74.024.000</b> GBP 38.00



### Base

To adjust the height. Colour: black.

Designation	
Housing base, black, height 50 mm	<b>74.047.000</b> GBP 34.00
Housing base, black, height 100 mm	<b>74.048.000</b> GBP 36.00



### Mobile model

Raised edging, 4-sided, incl. ribbed mat (black), 2 swivel castors with brakes, 2 fixed castors, max. load capacity 400kg, with either nylon or rubber wheels, 1 push handle.

Designation	
Retainer top with raised edges, 4-sided, incl. ribbed mat (black) and push handle	<b>74.035.000</b> GBP 70.00
Pair of castor supports, with nylon roller set ø 100 mm	<b>74.073.000</b> GBP 64.00
Pair of castor supports, with rubber roller set ø 100 mm	<b>74.074.000</b> GBP 85.00

# Partition material Lista Premium

Useable drawer dimension 306 x 612 mm (18 x 36E)

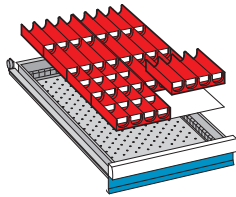

## Troughs

### For front height mm

50	<b>80.618.000</b> GBP 23.80
----	--------------------------------

8 trough-shaped parts: 4 grooves  
40 trough dividers: 4 grooves

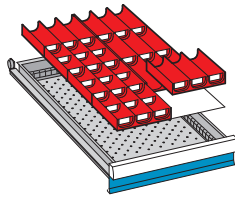

## Troughs

### For front height mm

50	<b>80.619.000</b> GBP 20.80
----	--------------------------------

8 trough-shaped parts: 3 grooves  
30 trough dividers: 3 grooves

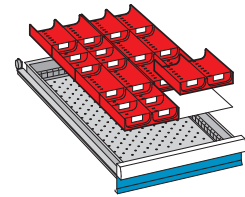

## Troughs

### For front height mm

50	<b>80.620.000</b> GBP 17.80
----	--------------------------------

8 trough-shaped parts: 2 grooves  
20 trough dividers: 2 grooves

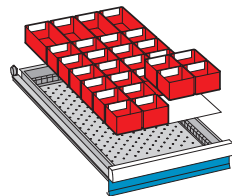

## Plastic boxes

### For front height mm

50	<b>80.621.000</b> GBP 21.00
75	<b>80.622.000</b> GBP 26.00

24 plastic boxes: 75 x 75 mm  
4 plastic boxes: 150 x 75 mm

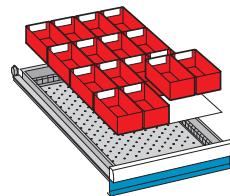

## Plastic boxes

### For front height mm

50	<b>80.623.000</b> GBP 14.30
75	<b>80.624.000</b> GBP 19.30
100	<b>80.625.000</b> GBP 33.50

16 plastic boxes: 150 x 75 mm

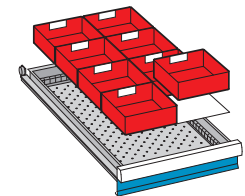

## Plastic boxes

### For front height mm

50	<b>80.626.000</b> GBP 12.30
75	<b>80.627.000</b> GBP 14.50
100	<b>80.628.000</b> GBP 19.30

8 plastic boxes: 150 x 150 mm

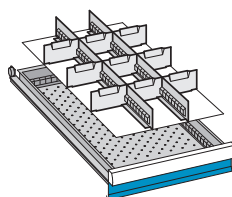

## Dividers

### For front height mm

50	<b>80.629.000</b> GBP 9.80
75	<b>80.630.000</b> GBP 11.30
100	<b>80.631.000</b> GBP 14.30
150	<b>80.632.000</b> GBP 17.30

2 slotted partitions: 36E  
9 dividers: 6E

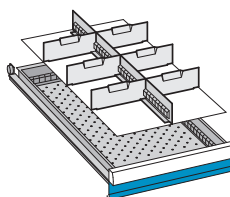

## Dividers

### For front height mm

50	<b>80.633.000</b> GBP 6.50
75	<b>80.634.000</b> GBP 7.50
100	<b>80.635.000</b> GBP 9.50
150	<b>80.636.000</b> GBP 10.80
200	<b>80.637.000</b> GBP 13.00
300	<b>80.638.000</b> GBP 19.30

1 slotted partition: 36E  
6 dividers: 9E

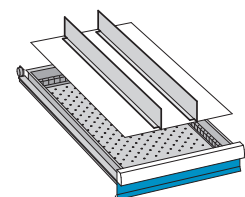

## Dividers

### For front height mm

75	<b>100.265.000</b> GBP 3.80
100, 125	<b>100.266.000</b> GBP 4.90
150	<b>100.267.000</b> GBP 6.00
200	<b>100.268.000</b> GBP 7.50

2 plain partitions: 36E

## Partition material Lista Premium

Useable drawer dimension 306 x 612 mm (18 x 36E)

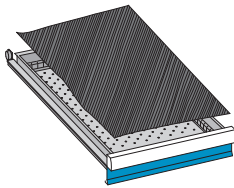

### Anti-slide mat

#### Designation

Anti-slide mat anthracite	<b>119.000.000</b> GBP 3.00
---------------------------	--------------------------------

Coating: special soft PVC foam.  
Extremely hardwearing and tear-proof.

### Lista Script labels for partition material

Label size mm	Used for	Number	
47 x 18	Plastic boxes, clip-on label holders	2 sheets (A4), 52 labels each	<b>18.785.000</b> GBP 1.60
47 x 12	Plastic boxes, clip-on label holders	2 sheets (A4), 76 labels each	<b>18.786.000</b> GBP 1.60
27 x 12	Plastic boxes, clip-on label holders	2 sheets (A4), 133 labels each	<b>18.787.000</b> GBP 1.60

### Lista Script labels for cabinet labelling

Label size mm	Used for	Number	
210 x 22 / 70 x 22	Drawer handle, drawer cabinet	5 sheets (A4), 10/30 labels each	<b>18.784.000</b> GBP 2.60

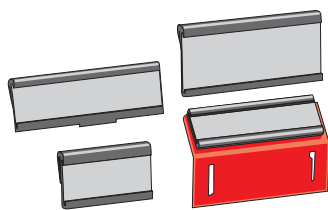

### Clip-on label holders for partition material

Label size mm	Used for	Number	
27 x 12	Trough dividers, dividers, etc.	20 clip-on label holder, 266 labels	<b>134.029.000</b> GBP 7.30
47 x 12	Plastic boxes	20 label holders red	<b>134.034.000</b> GBP 6.80
47 x 12	Dividers, etc.	20 clip-on label holder, 152 labels	<b>134.049.000</b> GBP 7.30
47 x 18	Dividers, etc.	20 clip-on label holder, 104 labels	<b>134.052.000</b> GBP 7.30



## Lista Premium drawer cabinets

Width 564 mm, depth 572 mm (27 x 27E)

### Configuration examples



## Lista Premium drawer cabinets

Width 564 mm, depth 572 mm (27 x 27E)

**Configuration instructions: this is how to put your drawer cabinet together.**

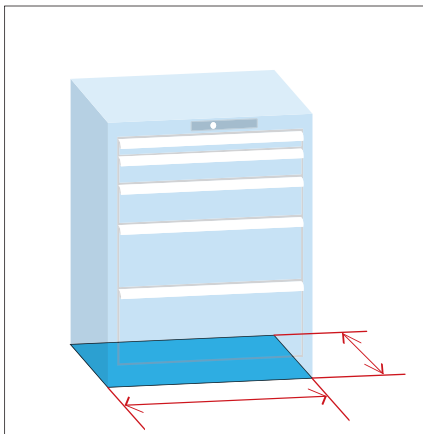

### 1. Selection of the cabinet base area

The first step is the selection of the cabinet base area. It can be indicated in millimetres (width x depth) or Lista units (E x E). The measurements E x E indicate which drawers match which housings.

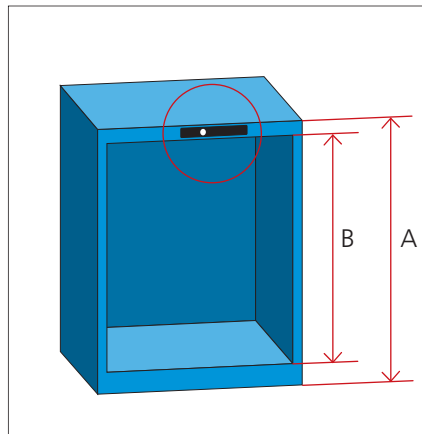

### 2. Selection of housing and locking system

After selecting a base area you can specify the housing. Different heights are available for every floor plan. The selection of housing always includes the choice of the desired locking system and colour.

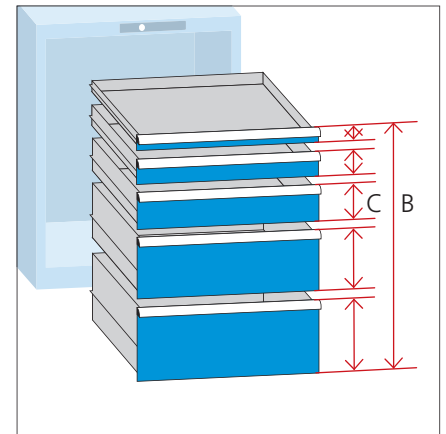

### 3. Selection of drawers

Determine the front height, carrying capacity, and colour of the drawers. The sum total of the front heights C must correspond to the clear height B (refer to figure in point 2). Please also select the type of safety catch.



### 4. Selection of accessories

The drawer cabinet can be combined with hinged door, plain shelves and pull-out shelves. Further housing accessories (cover, base, wheels and push handle for mobile cabinets) are also available. Mobile cabinets must be fitted with a drawer safety catch.

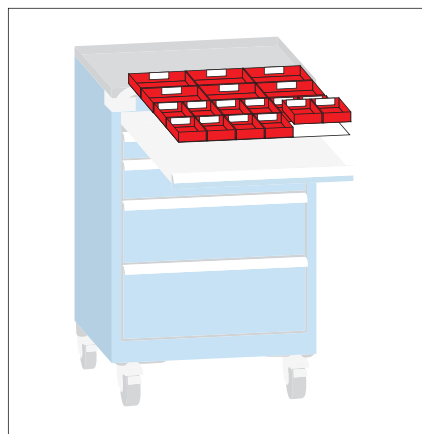

### 5. Selection of partition material

Partition material for drawers is usually ordered as a set. The available selection is large. Please note: The partition material must match the drawer height and useable dimension.

### 6. Determination of the price

The price of the drawer cabinet corresponds to the sum of all selected elements in the corresponding configuration.

# Drawer cabinets Lista Premium

## Width 564 mm, depth 572 mm (27 x 27E)

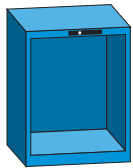

### Housing

Height mm	Clear height mm	Key Lock	Code Lock	Remote Lock	Remote Lock Mobile	Lock without cylinder
283	200	<b>71.070.XXX</b> GBP 137.00	<b>71.129.XXX</b> GBP 177.00	<b>71.188.XXX</b> GBP 292.00		<b>71.011.XXX</b> GBP 128.00
383	300	<b>71.071.XXX</b> GBP 140.00	<b>71.130.XXX</b> GBP 180.00	<b>71.189.XXX</b> GBP 295.00		<b>71.012.XXX</b> GBP 131.00
533	450	<b>71.072.XXX</b> GBP 150.00	<b>71.131.XXX</b> GBP 190.00	<b>71.190.XXX</b> GBP 305.00	<b>71.243.XXX</b> GBP 375.00	<b>71.013.XXX</b> GBP 141.00
650	550	<b>71.073.XXX</b> GBP 163.00	<b>71.132.XXX</b> GBP 203.00	<b>71.191.XXX</b> GBP 318.00	<b>71.244.XXX</b> GBP 388.00	<b>71.014.XXX</b> GBP 154.00
700	600	<b>71.074.XXX</b> GBP 167.00	<b>71.133.XXX</b> GBP 207.00	<b>71.192.XXX</b> GBP 322.00	<b>71.245.XXX</b> GBP 392.00	<b>71.015.XXX</b> GBP 158.00
800	700	<b>71.075.XXX</b> GBP 174.00	<b>71.134.XXX</b> GBP 214.00	<b>71.193.XXX</b> GBP 329.00	<b>71.246.XXX</b> GBP 399.00	<b>71.016.XXX</b> GBP 165.00
850	750	<b>71.076.XXX</b> GBP 182.00	<b>71.135.XXX</b> GBP 222.00	<b>71.194.XXX</b> GBP 337.00	<b>71.247.XXX</b> GBP 407.00	<b>71.017.XXX</b> GBP 173.00
1000	900	<b>71.077.XXX</b> GBP 198.00	<b>71.136.XXX</b> GBP 238.00	<b>71.195.XXX</b> GBP 353.00	<b>71.248.XXX</b> GBP 423.00	<b>71.018.XXX</b> GBP 189.00

### Accessories Remote Lock

Designation	
Hand-held radio transmitter	<b>74.092.000</b> GBP 23.00
Programming key	<b>74.093.000</b> GBP 33.00
Adapter	<b>74.094.000</b> GBP 33.00
Extension unit 2-pole, 1850 mm	<b>74.098.000</b> GBP 23.00
Extension unit 4-pole, 1850 mm	<b>74.099.000</b> GBP 25.00

### Accessories drawer cabinet without cylinder

Designation	
Cylinder 2C 1 simultaneously lockable	<b>222.377.000</b> GBP 11.00
Cylinder 2C 2 simultaneously lockable	<b>222.378.000</b> GBP 11.00
Cylinder 2C 3 simultaneously lockable	<b>222.379.000</b> GBP 11.00
Cylinder 2C 4 simultaneously lockable	<b>222.380.000</b> GBP 11.00
Cylinder 2C 5 simultaneously lockable	<b>222.381.000</b> GBP 11.00
Cylinder 2C 6 simultaneously lockable	<b>222.382.000</b> GBP 11.00
Cylinder 2C _ simultaneously lockable	<b>222.383.000</b> GBP 12.00
Cylinder main locking system	<b>222.384.000</b> GBP 16.00

### The Lista housing locks

#### Key Lock

Standard closure with central locking system and Lista cylinder lock, individual lock, with 2 keys.

#### Code Lock

Electronic locking system, a number combination replaces the key. Programmable user codes allow a flexible locking system to be created. Battery powered.

#### Remote Lock

Electronic locking system with hand-held radio transmitter (unlocking through radio pulse). A programming key grants access and authorisation. Interlinking of cabinets possible using interlink elements. Connects to main supply (adapter necessary). Please note: hand-held radio transmitter, programming key and adapter not included. Can be ordered optionally if required.

#### Remote Lock Mobile

Same functionality as Remote Lock, but with rechargeable battery (requirement for mobile model). Hand-held radio transmitter and programming key not included. Can be ordered optionally if required.

#### Lock without cylinder

Lock to be included in complete locking systems (simultaneously or main locking systems). For cylinders ordered with predefined lock numbers (2C 1 – 2C 6) or a freely defined number (2C \_). Should a cylinder not be ordered, the housing will be supplied with a lock cover.

For further information on locking systems see page 17.

### The Lista standard colours (without extra charge)

Please complete the last 3 digits of your product code (.XXX) with the desired colour code.

<b>.010</b>	<b>.020</b>	<b>.030</b>	<b>.040</b>	<b>.050</b>	<b>.060</b>	<b>.070</b>	<b>.080</b>	<b>.090</b>	<b>.100</b>
Light blue RAL 5012	Light grey RAL 7035	Reseda green RAL 6011	Capri blue RAL 5019	Grey metallic NCS S 6502-B	Black NCS S 9000-N	Ruby red RAL 3003	Pigeon grey NCS S 4502-B	Gentian blue RAL 5010	Signal blue RAL 5005

# Drawers Lista Premium

Useable drawer dimension 459 x 459 mm (27 x 27E)

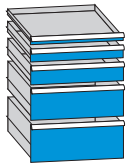

## Drawers 75 kg

Front height mm (useable height)	Standard	Safety catch on the right	Safety catch on the right and left	Double safety catch	Lilo locking device
50 (29)	<b>72.012.XXX</b> GBP 52.00	<b>72.122.XXX</b> GBP 53.00	<b>72.232.XXX</b> GBP 54.00	<b>72.342.XXX</b> GBP 72.00	
75 (54)	<b>72.013.XXX</b> GBP 59.00	<b>72.123.XXX</b> GBP 60.00	<b>72.233.XXX</b> GBP 61.00	<b>72.343.XXX</b> GBP 79.00	
100 (79)	<b>72.015.XXX</b> GBP 60.00	<b>72.125.XXX</b> GBP 61.00	<b>72.235.XXX</b> GBP 62.00	<b>72.345.XXX</b> GBP 80.00	
125 (104)	<b>72.017.XXX</b> GBP 62.00	<b>72.127.XXX</b> GBP 63.00	<b>72.237.XXX</b> GBP 64.00	<b>72.347.XXX</b> GBP 82.00	
150 (129)	<b>72.019.XXX</b> GBP 66.00	<b>72.129.XXX</b> GBP 67.00	<b>72.239.XXX</b> GBP 68.00	<b>72.349.XXX</b> GBP 86.00	
200 (179)	<b>72.021.XXX</b> GBP 73.00	<b>72.131.XXX</b> GBP 74.00	<b>72.241.XXX</b> GBP 75.00	<b>72.351.XXX</b> GBP 93.00	
250 (229)	<b>72.023.XXX</b> GBP 79.00	<b>72.133.XXX</b> GBP 80.00	<b>72.243.XXX</b> GBP 81.00	<b>72.353.XXX</b> GBP 99.00	
300 (279)	<b>72.025.XXX</b> GBP 85.00	<b>72.135.XXX</b> GBP 86.00	<b>72.245.XXX</b> GBP 87.00	<b>72.355.XXX</b> GBP 105.00	

## Drawers 200 kg

Front height mm (useable height)	Standard	Safety catch on the right	Safety catch on the right and left	Double safety catch	Lilo locking device
75 (54)	<b>72.014.XXX</b> GBP 79.00	<b>72.124.XXX</b> GBP 80.00	<b>72.234.XXX</b> GBP 81.00	<b>72.344.XXX</b> GBP 99.00	<b>72.440.XXX</b> GBP 104.00
100 (79)	<b>72.016.XXX</b> GBP 80.00	<b>72.126.XXX</b> GBP 81.00	<b>72.236.XXX</b> GBP 82.00	<b>72.346.XXX</b> GBP 100.00	<b>72.441.XXX</b> GBP 105.00
125 (104)	<b>72.018.XXX</b> GBP 82.00	<b>72.128.XXX</b> GBP 83.00	<b>72.238.XXX</b> GBP 84.00	<b>72.348.XXX</b> GBP 102.00	<b>72.442.XXX</b> GBP 107.00
150 (129)	<b>72.020.XXX</b> GBP 86.00	<b>72.130.XXX</b> GBP 87.00	<b>72.240.XXX</b> GBP 88.00	<b>72.350.XXX</b> GBP 106.00	<b>72.443.XXX</b> GBP 111.00
200 (179)	<b>72.022.XXX</b> GBP 93.00	<b>72.132.XXX</b> GBP 94.00	<b>72.242.XXX</b> GBP 95.00	<b>72.352.XXX</b> GBP 113.00	<b>72.444.XXX</b> GBP 118.00
250 (229)	<b>72.024.XXX</b> GBP 99.00	<b>72.134.XXX</b> GBP 100.00	<b>72.244.XXX</b> GBP 101.00	<b>72.354.XXX</b> GBP 119.00	<b>72.445.XXX</b> GBP 124.00
300 (279)	<b>72.026.XXX</b> GBP 105.00	<b>72.136.XXX</b> GBP 106.00	<b>72.246.XXX</b> GBP 107.00	<b>72.356.XXX</b> GBP 125.00	<b>72.446.XXX</b> GBP 130.00

## The Lista drawer safety catch

### Standard

Standard model without drawer-locking facility.

### Safety catch on the right

Mobile cabinets must be fitted with a drawer safety catch. Prevents unintended opening of drawers even when the cabinet is not locked.

### Safety catch on the right and left as well as double safety catch

Increased safety for use on mobile equipment. Safety catch right and left, operated with both hands. Double catch centrally operated with one hand.

### Lilo locking device

The Lilo locking device (Lock-in – Lock-out) blocks the drawer in an open or closed state. A significant security and comfort benefit, especially for heavy loads.

## The Lista standard colours (without extra charge)

Please complete the last 3 digits of your product code (.XXX) with the desired colour code.

<b>.010</b>	<b>.020</b>	<b>.030</b>	<b>.040</b>	<b>.050</b>	<b>.060</b>	<b>.070</b>	<b>.080</b>	<b>.090</b>	<b>.100</b>
Light blue RAL 5012	Light grey RAL 7035	Reseda green RAL 6011	Capri blue RAL 5019	Grey metallic NCS S 6502-B	Black NCS S 9000-N	Ruby red RAL 3003	Pigeon grey NCS S 4502-B	Gentian blue RAL 5010	Signal blue RAL 5005

# Hinged doors and housing accessories Lista Premium

## Width 564 mm, depth 572 mm (27 x 27E)



### Door mounted on the right

As front closure for the pull-out and adjustable shelves installed in the housing under the drawers. The sum total of the door front height together with all drawer front heights must equal the height clearance of the cabinet housing. Model: made of sheet steel. Colour: see colour chart page 11.

Height mm	Description	
450	With cylinder lock	<b>74.002.XXX</b> GBP 64.00
600	With cylinder lock	<b>74.003.XXX</b> GBP 69.00

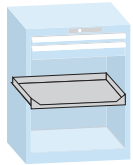

### Pull-out shelf, load capacity 75 kg

The 25-mm divisions in the vertical supports of the cabinet housing allow the pull-out shelves to be mounted in the same cabinet housing in any order. Model: made of sheet steel. Colour: grey NCS S 4502-B.

Height mm	
100	<b>74.008.000</b> GBP 65.00



### Adjustable shelf, load capacity 75 kg

The 25-mm divisions in the vertical supports of the cabinet housing allow the shelves to be mounted in the same cabinet housing in any order. Model: made of sheet steel. Colour: grey NCS S 4502-B.

Height mm	
75	<b>74.009.000</b> GBP 28.00

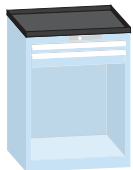

### Cover

Available with or without raised edging. Colour: black.

Designation	
Ribbed mat, single, black	<b>74.014.000</b> GBP 15.00
Retainer top with raised edges, 3-sided, incl. ribbed mat (black)	<b>74.025.000</b> GBP 40.00



### Base

To adjust the height. Colour: black.

Designation	
Housing base, black, height 50 mm	<b>74.049.000</b> GBP 35.00
Housing base, black, height 100 mm	<b>74.050.000</b> GBP 37.00



### Mobile model

Raised edging, 4-sided, incl. ribbed mat (black), 2 swivel castors with brakes, 2 fixed castors, max. load capacity 400kg, with either nylon or rubber wheels, 1 push handle.

Designation	
Retainer top with raised edges, 4-sided, incl. ribbed mat (black) and push handle	<b>74.036.000</b> GBP 71.00
Pair of castor supports, with nylon roller set ø 100 mm	<b>74.071.000</b> GBP 62.00
Pair of castor supports, with rubber roller set ø 100 mm	<b>74.072.000</b> GBP 82.00
Pair of castor supports, with rubber roller set ø 160 mm	<b>74.075.000</b> GBP 128.00

# Partition material Lista Premium

Useable drawer dimension 459 x 459 mm (27 x 27E)

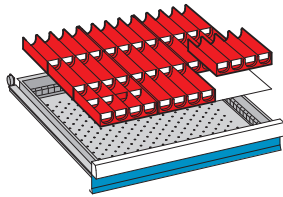

## Troughs

For front height mm	
50	<b>80.656.000</b> GBP 25.50
9 trough-shaped parts: 4 grooves 40 trough dividers: 4 grooves	

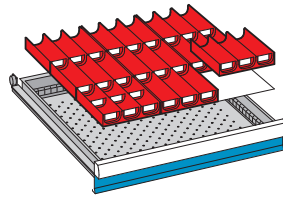

## Troughs

For front height mm	
50	<b>80.657.000</b> GBP 22.50
9 trough-shaped parts: 3 grooves 30 trough dividers: 3 grooves	

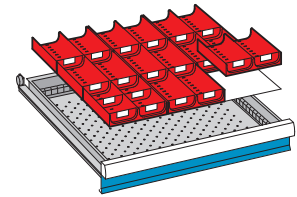

## Troughs

For front height mm	
50	<b>80.658.000</b> GBP 19.50
9 trough-shaped parts: 2 grooves 20 trough dividers: 2 grooves	

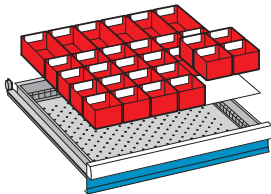

## Plastic boxes

For front height mm	
50	<b>80.659.000</b> GBP 22.80
75	<b>80.660.000</b> GBP 28.50
24 plastic boxes: 75 x 75 mm 6 plastic boxes: 150 x 75 mm	

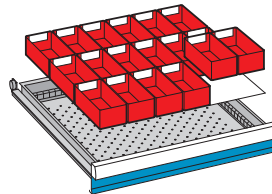

## Plastic boxes

For front height mm	
50	<b>80.661.000</b> GBP 16.00
75	<b>80.662.000</b> GBP 21.50
100, 125	<b>80.663.000</b> GBP 37.50
18 plastic boxes: 150 x 75 mm	

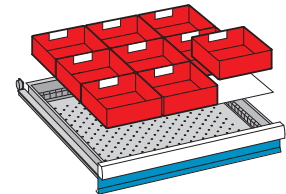

## Plastic boxes

For front height mm	
50	<b>80.664.000</b> GBP 13.80
75	<b>80.665.000</b> GBP 16.50
100, 125	<b>80.666.000</b> GBP 21.50
9 plastic boxes: 150 x 150 mm	

## Partition material Lista Premium

Useable drawer dimension 459 x 459 mm (27 x 27E)

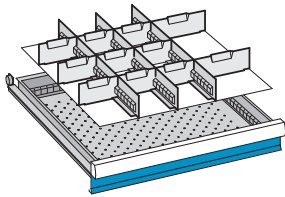

### Dividers

For front height mm	
50	<b>80.667.000</b> GBP 13.30
75	<b>80.668.000</b> GBP 15.00
100, 125	<b>80.669.000</b> GBP 19.50
150	<b>80.670.000</b> GBP 23.50
3 slotted partitions: 27E 9 dividers: 6E 2 dividers: 9E	

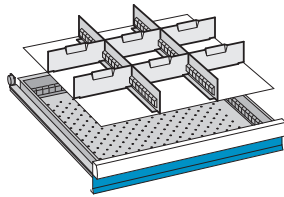

### Dividers

For front height mm	
50	<b>80.671.000</b> GBP 9.00
75	<b>80.672.000</b> GBP 10.00
100, 125	<b>80.673.000</b> GBP 13.30
150	<b>80.674.000</b> GBP 15.30
200	<b>80.675.000</b> GBP 19.00
250	<b>80.676.000</b> GBP 22.50
300	<b>80.677.000</b> GBP 26.50
2 slotted partitions: 27E 6 dividers: 9E	

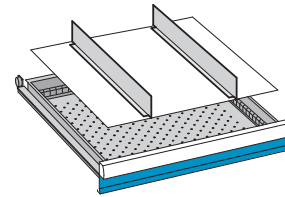

### Dividers

For front height mm	
75	<b>100.315.000</b> GBP 3.60
100, 125	<b>100.130.000</b> GBP 4.50
150	<b>100.131.000</b> GBP 5.80
200	<b>100.132.000</b> GBP 7.30
250	<b>100.133.000</b> GBP 8.80
2 plain partitions: 27E	

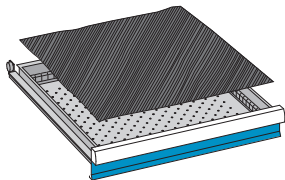

### Anti-slide mat

Designation	
Anti-slide mat anthracite	<b>119.020.000</b> GBP 3.50
Coating: special soft PVC foam. Extremely hardwearing and tear-proof.	

## Partition material Lista Premium

Useable drawer dimension 459 x 459 mm (27 x 27E)

### Lista Script labels for partition material

Label size mm	Used for	Number	
47 x 18	Plastic boxes, clip-on label holders	2 sheets (A4), 52 labels each	<b>18.785.000</b> GBP 1.60
47 x 12	Plastic boxes, clip-on label holders	2 sheets (A4), 76 labels each	<b>18.786.000</b> GBP 1.60
27 x 12	Plastic boxes, clip-on label holders	2 sheets (A4), 133 labels each	<b>18.787.000</b> GBP 1.60

### Lista Script labels for cabinet labelling

Label size mm	Used for	Number	
210 x 22 / 70 x 22	Drawer handle, drawer cabinet	5 sheets (A4), 10/30 labels each	<b>18.784.000</b> GBP 2.60

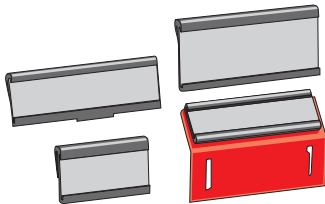

### Clip-on label holders for partition material

Label size mm	Used for	Number	
27 x 12	Trough dividers, dividers, etc.	20 clip-on label holder, 266 labels	<b>134.029.000</b> GBP 7.30
47 x 12	Plastic boxes	20 label holders red	<b>134.034.000</b> GBP 6.80
47 x 12	Dividers, etc.	20 clip-on label holder, 152 labels	<b>134.049.000</b> GBP 7.30
47 x 18	Dividers, etc.	20 clip-on label holder, 104 labels	<b>134.052.000</b> GBP 7.30

## Lista Premium drawer cabinets

Width 564 mm, depth 725 mm (27 x 36E)

### Configuration examples



## Lista Premium drawer cabinets

Width 564 mm, depth 725 mm (27 x 36E)

**Configuration instructions: this is how to put your drawer cabinet together.**

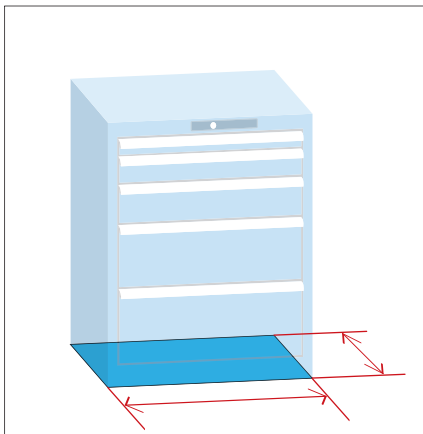

### 1. Selection of the cabinet base area

The first step is the selection of the cabinet base area. It can be indicated in millimetres (width x depth) or Lista units (E x E). The measurements E x E indicate which drawers match which housings.

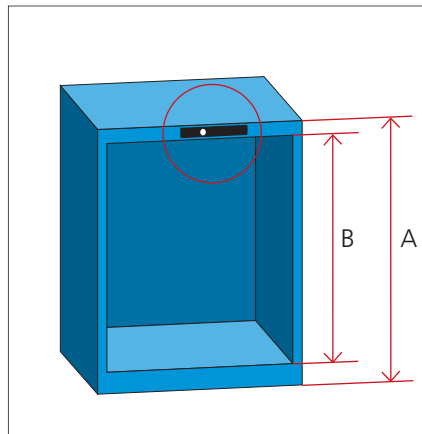

### 2. Selection of housing and locking system

After selecting a base area you can specify the housing. Different heights are available for every floor plan. The selection of housing always includes the choice of the desired locking system and colour.

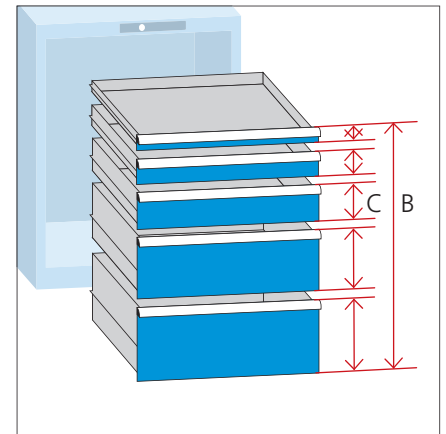

### 3. Selection of drawers

Determine the front height, carrying capacity, and colour of the drawers. The sum total of the front heights C must correspond to the clear height B (refer to figure in point 2). Please also select the type of safety catch.



### 4. Selection of accessories

The drawer cabinet can be combined with hinged door, plain shelves and pull-out shelves. Further housing accessories (cover, base, wheels and push handle for mobile cabinets) are also available. Mobile cabinets must be fitted with a drawer safety catch.



### 5. Selection of partition material

Partition material for drawers is usually ordered as a set. The available selection is large. Please note: The partition material must match the drawer height and useable dimension.

### 6. Determination of the price

The price of the drawer cabinet corresponds to the sum of all selected elements in the corresponding configuration.

# Drawer cabinets Lista Premium

## Width 564 mm, depth 725 mm (27 x 36E)

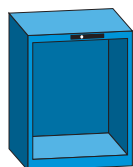

### Housing

Height mm	Clear height mm	Key Lock	Code Lock	Remote Lock	Remote Lock Mobile	Lock without cylinder
283	200	<b>71.078.XXX</b> GBP 148.00	<b>71.137.XXX</b> GBP 188.00	<b>71.196.XXX</b> GBP 303.00		<b>71.019.XXX</b> GBP 139.00
383	300	<b>71.079.XXX</b> GBP 151.00	<b>71.138.XXX</b> GBP 191.00	<b>71.197.XXX</b> GBP 306.00		<b>71.020.XXX</b> GBP 142.00
533	450	<b>71.080.XXX</b> GBP 166.00	<b>71.139.XXX</b> GBP 206.00	<b>71.198.XXX</b> GBP 321.00	<b>71.249.XXX</b> GBP 391.00	<b>71.021.XXX</b> GBP 157.00
650	550	<b>71.081.XXX</b> GBP 184.00	<b>71.140.XXX</b> GBP 224.00	<b>71.199.XXX</b> GBP 339.00	<b>71.250.XXX</b> GBP 409.00	<b>71.022.XXX</b> GBP 175.00
700	600	<b>71.082.XXX</b> GBP 187.00	<b>71.141.XXX</b> GBP 227.00	<b>71.200.XXX</b> GBP 342.00	<b>71.251.XXX</b> GBP 412.00	<b>71.023.XXX</b> GBP 178.00
800	700	<b>71.083.XXX</b> GBP 199.00	<b>71.142.XXX</b> GBP 239.00	<b>71.201.XXX</b> GBP 354.00	<b>71.252.XXX</b> GBP 424.00	<b>71.024.XXX</b> GBP 190.00
850	750	<b>71.084.XXX</b> GBP 206.00	<b>71.143.XXX</b> GBP 246.00	<b>71.202.XXX</b> GBP 361.00	<b>71.253.XXX</b> GBP 431.00	<b>71.025.XXX</b> GBP 197.00
1000	900	<b>71.085.XXX</b> GBP 223.00	<b>71.144.XXX</b> GBP 263.00	<b>71.203.XXX</b> GBP 378.00	<b>71.254.XXX</b> GBP 448.00	<b>71.026.XXX</b> GBP 214.00

### Accessories Remote Lock

Designation	
Hand-held radio transmitter	<b>74.092.000</b> GBP 23.00
Programming key	<b>74.093.000</b> GBP 33.00
Adapter	<b>74.094.000</b> GBP 33.00
Extension unit 2-pole, 1850 mm	<b>74.098.000</b> GBP 23.00
Extension unit 4-pole, 1850 mm	<b>74.099.000</b> GBP 25.00

### Accessories drawer cabinet without cylinder

Designation	
Cylinder 2C 1 simultaneously lockable	<b>222.377.000</b> GBP 11.00
Cylinder 2C 2 simultaneously lockable	<b>222.378.000</b> GBP 11.00
Cylinder 2C 3 simultaneously lockable	<b>222.379.000</b> GBP 11.00
Cylinder 2C 4 simultaneously lockable	<b>222.380.000</b> GBP 11.00
Cylinder 2C 5 simultaneously lockable	<b>222.381.000</b> GBP 11.00
Cylinder 2C 6 simultaneously lockable	<b>222.382.000</b> GBP 11.00
Cylinder 2C _ simultaneously lockable	<b>222.383.000</b> GBP 12.00
Cylinder main locking system	<b>222.384.000</b> GBP 16.00

### The Lista standard colours (without extra charge)

Please complete the last 3 digits of your product code (.XXX) with the desired colour code.

<b>.010</b>	<b>.020</b>	<b>.030</b>	<b>.040</b>	<b>.050</b>	<b>.060</b>	<b>.070</b>	<b>.080</b>	<b>.090</b>	<b>.100</b>
Light blue RAL 5012	Light grey RAL 7035	Reseda green RAL 6011	Capri blue RAL 5019	Grey metallic NCS S 6502-B	Black NCS S 9000-N	Ruby red RAL 3003	Pigeon grey NCS S 4502-B	Gentian blue RAL 5010	Signal blue RAL 5005

### The Lista housing locks

#### Key Lock

Standard closure with central locking system and Lista cylinder lock, individual lock, with 2 keys.

#### Code Lock

Electronic locking system, a number combination replaces the key. Programmable user codes allow a flexible locking system to be created. Battery powered.

#### Remote Lock

Electronic locking system with hand-held radio transmitter (unlocking through radio pulse). A programming key grants access and authorisation. Interlinking of cabinets possible using interlink elements. Connects to main supply (adapter necessary). Please note: hand-held radio transmitter, programming key and adapter not included. Can be ordered optionally if required.

#### Remote Lock Mobile

Same functionality as Remote Lock, but with rechargeable battery (requirement for mobile model). Hand-held radio transmitter and programming key not included. Can be ordered optionally if required.

#### Lock without cylinder

Lock to be included in complete locking systems (simultaneously or main locking systems). For cylinders ordered with predefined lock numbers (2C 1 – 2C 6) or a freely defined number (2C \_). Should a cylinder not be ordered, the housing will be supplied with a lock cover.

For further information on locking systems see page 17.

# Drawers Lista Premium

Useable drawer dimension 459 x 612 mm (27 x 36E)

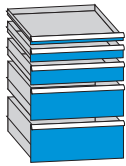

## Drawers 75 kg

Front height mm (useable height)	Standard	Safety catch on the right	Safety catch on the right and left	Double safety catch	Lilo locking device
50 (29)	<b>72.027.XXX</b> GBP 54.00	<b>72.137.XXX</b> GBP 55.00	<b>72.247.XXX</b> GBP 56.00	<b>72.357.XXX</b> GBP 74.00	
75 (54)	<b>72.028.XXX</b> GBP 62.00	<b>72.138.XXX</b> GBP 63.00	<b>72.248.XXX</b> GBP 64.00	<b>72.358.XXX</b> GBP 82.00	
100 (79)	<b>72.030.XXX</b> GBP 65.00	<b>72.140.XXX</b> GBP 66.00	<b>72.250.XXX</b> GBP 67.00	<b>72.360.XXX</b> GBP 85.00	
125 (104)	<b>72.032.XXX</b> GBP 67.00	<b>72.142.XXX</b> GBP 68.00	<b>72.252.XXX</b> GBP 69.00	<b>72.362.XXX</b> GBP 87.00	
150 (129)	<b>72.034.XXX</b> GBP 68.00	<b>72.144.XXX</b> GBP 69.00	<b>72.254.XXX</b> GBP 70.00	<b>72.364.XXX</b> GBP 88.00	
200 (179)	<b>72.036.XXX</b> GBP 78.00	<b>72.146.XXX</b> GBP 79.00	<b>72.256.XXX</b> GBP 80.00	<b>72.366.XXX</b> GBP 98.00	
250 (229)	<b>72.038.XXX</b> GBP 83.00	<b>72.148.XXX</b> GBP 84.00	<b>72.258.XXX</b> GBP 85.00	<b>72.368.XXX</b> GBP 103.00	
300 (279)	<b>72.040.XXX</b> GBP 89.00	<b>72.150.XXX</b> GBP 90.00	<b>72.260.XXX</b> GBP 91.00	<b>72.370.XXX</b> GBP 109.00	

## Drawers 200 kg

Front height mm (useable height)	Standard	Safety catch on the right	Safety catch on the right and left	Double safety catch	Lilo locking device
75 (54)	<b>72.029.XXX</b> GBP 82.00	<b>72.139.XXX</b> GBP 83.00	<b>72.249.XXX</b> GBP 84.00	<b>72.359.XXX</b> GBP 102.00	<b>72.447.XXX</b> GBP 107.00
100 (79)	<b>72.031.XXX</b> GBP 85.00	<b>72.141.XXX</b> GBP 86.00	<b>72.251.XXX</b> GBP 87.00	<b>72.361.XXX</b> GBP 105.00	<b>72.448.XXX</b> GBP 110.00
125 (104)	<b>72.033.XXX</b> GBP 87.00	<b>72.143.XXX</b> GBP 88.00	<b>72.253.XXX</b> GBP 89.00	<b>72.363.XXX</b> GBP 107.00	<b>72.449.XXX</b> GBP 112.00
150 (129)	<b>72.035.XXX</b> GBP 88.00	<b>72.145.XXX</b> GBP 89.00	<b>72.255.XXX</b> GBP 90.00	<b>72.365.XXX</b> GBP 108.00	<b>72.450.XXX</b> GBP 113.00
200 (179)	<b>72.037.XXX</b> GBP 98.00	<b>72.147.XXX</b> GBP 99.00	<b>72.257.XXX</b> GBP 100.00	<b>72.367.XXX</b> GBP 118.00	<b>72.451.XXX</b> GBP 123.00
250 (229)	<b>72.039.XXX</b> GBP 103.00	<b>72.149.XXX</b> GBP 104.00	<b>72.259.XXX</b> GBP 105.00	<b>72.369.XXX</b> GBP 123.00	<b>72.452.XXX</b> GBP 128.00
300 (279)	<b>72.041.XXX</b> GBP 109.00	<b>72.151.XXX</b> GBP 110.00	<b>72.261.XXX</b> GBP 111.00	<b>72.371.XXX</b> GBP 129.00	<b>72.453.XXX</b> GBP 134.00

## The Lista drawer safety catch

### Standard

Standard model without drawer-locking facility.

### Safety catch on the right

Mobile cabinets must be fitted with a drawer safety catch. Prevents unintended opening of drawers even when the cabinet is not locked.

### Safety catch on the right and left as well as double safety catch

Increased safety for use on mobile equipment. Safety catch right and left, operated with both hands. Double catch centrally operated with one hand.

### Lilo locking device

The Lilo locking device (Lock-in – Lock-out) blocks the drawer in an open or closed state. A significant security and comfort benefit, especially for heavy loads.

## The Lista standard colours (without extra charge)

Please complete the last 3 digits of your product code (.XXX) with the desired colour code.

<b>.010</b>	<b>.020</b>	<b>.030</b>	<b>.040</b>	<b>.050</b>	<b>.060</b>	<b>.070</b>	<b>.080</b>	<b>.090</b>	<b>.100</b>
Light blue RAL 5012	Light grey RAL 7035	Reseda green RAL 6011	Capri blue RAL 5019	Grey metallic NCS S 6502-B	Black NCS S 9000-N	Ruby red RAL 3003	Pigeon grey NCS S 4502-B	Gentian blue RAL 5010	Signal blue RAL 5005

# Hinged doors and housing accessories Lista Premium

## Width 564 mm, depth 725 mm (27 x 36E)



### Door mounted on the right

As front closure for the pull-out and adjustable shelves installed in the housing under the drawers. The sum total of the door front height together with all drawer front heights must equal the height clearance of the cabinet housing. Model: made of sheet steel. Colour: see colour chart page 11.

Height mm	Description	
450	With cylinder lock	<b>74.002.XXX</b> GBP 64.00
600	With cylinder lock	<b>74.003.XXX</b> GBP 69.00

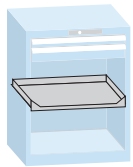

### Pull-out shelf, load capacity 75 kg

The 25-mm divisions in the vertical supports of the cabinet housing allow the pull-out shelves to be mounted in the same cabinet housing in any order. Model: made of sheet steel. Colour: grey NCS S 4502-B.

Height mm	
100	<b>74.010.000</b> GBP 70.00



### Adjustable shelf, load capacity 75 kg

The 25-mm divisions in the vertical supports of the cabinet housing allow the shelves to be mounted in the same cabinet housing in any order. Model: made of sheet steel. Colour: grey NCS S 4502-B.

Height mm	
75	<b>74.011.000</b> GBP 30.00

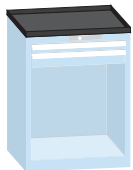

### Cover

Available with or without raised edging. Colour: black.

Designation	
Ribbed mat, single, black	<b>74.015.000</b> GBP 18.00
Retainer top with raised edges, 3-sided, incl. ribbed mat (black)	<b>74.026.000</b> GBP 45.00



### Base

To adjust the height. Colour: black.

Designation	
Housing base, black, height 50 mm	<b>74.051.000</b> GBP 36.00
Housing base, black, height 100 mm	<b>74.052.000</b> GBP 38.00



### Mobile model

Raised edging, 4-sided, incl. ribbed mat (black), 2 swivel castors with brakes, 2 fixed castors, max. load capacity 400kg, with either nylon or rubber wheels, 1 push handle.

Designation	
Retainer top with raised edges, 4-sided, incl. ribbed mat (black) and push handle	<b>74.037.000</b> GBP 77.00
Pair of castor supports, with nylon roller set ø 100 mm	<b>74.073.000</b> GBP 64.00
Pair of castor supports, with rubber roller set ø 100 mm	<b>74.074.000</b> GBP 85.00
Pair of castor supports, with rubber roller set ø 160 mm	<b>74.076.000</b> GBP 131.00

# Partition material Lista Premium

Useable drawer dimension 459 x 612 mm (27 x 36E)

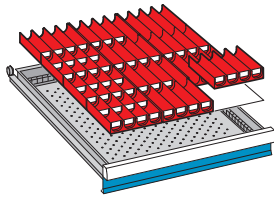

## Troughs

### For front height mm

50	<b>100.283.000</b> GBP 33.50
----	---------------------------------

12 trough-shaped parts:  
4 grooves  
50 trough dividers: 4 grooves

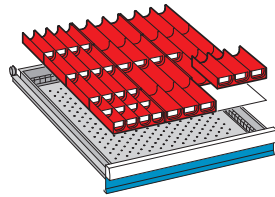

## Troughs

### For front height mm

50	<b>100.284.000</b> GBP 28.50
----	---------------------------------

4 trough-shaped parts: 4 grooves  
20 trough dividers: 4 grooves  
8 trough-shaped parts: 3 grooves  
10 trough dividers: 3 grooves

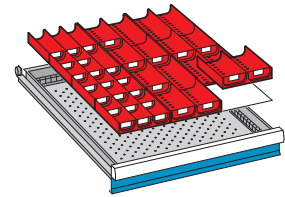

## Troughs

### For front height mm

50	<b>100.286.000</b> GBP 27.00
----	---------------------------------

4 trough-shaped parts: 3 grooves  
20 trough dividers: 3 grooves  
8 trough-shaped parts: 2 grooves  
10 trough dividers: 2 grooves

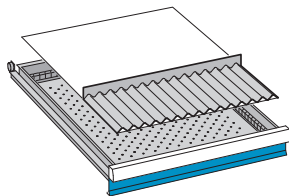

## Corrugated insert

### For front height mm

50	<b>100.295.000</b> GBP 6.30
----	--------------------------------

1 corrugated insert  
1 plain partition: 27E

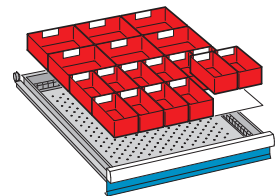

## Plastic boxes

### For front height mm

50	<b>100.292.000</b> GBP 19.80
75	<b>100.293.000</b> GBP 25.50
100, 125	<b>100.294.000</b> GBP 39.50

12 plastic boxes: 150 x 75 mm  
6 plastic boxes: 150 x 150 mm

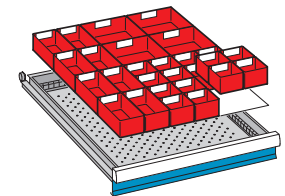

## Plastic boxes

### For front height mm

50	<b>100.290.000</b> GBP 24.80
75	<b>100.291.000</b> GBP 31.00

16 plastic boxes: 75 x 75 mm  
8 plastic boxes: 150 x 75 mm  
4 plastic boxes: 150 x 150 mm

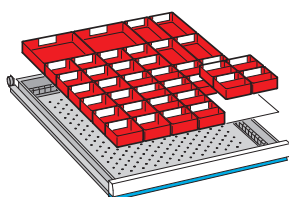

## Plastic boxes

### For front height mm

50	<b>100.288.000</b> GBP 31.00
----	---------------------------------

16 plastic boxes with centre divider: 75 x 75 mm  
16 plastic boxes: 75 x 75 mm  
4 plastic boxes: 150 x 75 mm  
2 plastic boxes: 150 x 150 mm

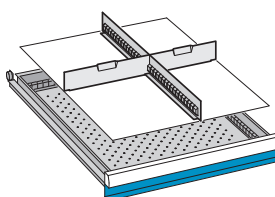

## Dividers

### For front height mm

75	<b>100.270.000</b> GBP 4.80
100, 125	<b>100.271.000</b> GBP 6.00
150	<b>100.272.000</b> GBP 7.50
200	<b>100.273.000</b> GBP 9.50
250	<b>80.691.000</b> GBP 11.50

1 slotted partition: 36E  
1 divider: 12E  
1 divider: 15E

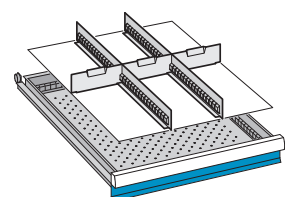

## Dividers

### For front height mm

75	<b>100.275.000</b> GBP 8.30
100, 125	<b>100.276.000</b> GBP 10.80
150	<b>100.277.000</b> GBP 13.00
200	<b>100.278.000</b> GBP 15.30
250	<b>80.692.000</b> GBP 18.50

2 slotted partitions: 36E  
3 dividers: 9E

# Partition material Lista Premium

Useable drawer dimension 459 x 612 mm (27 x 36E)

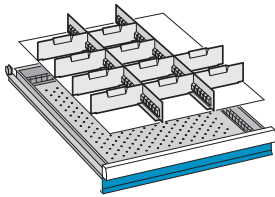

## Dividers

For front height mm	
50	<b>100.244.000</b> GBP 11.80
75	<b>100.245.000</b> GBP 13.30
100, 125	<b>100.246.000</b> GBP 17.00
150	<b>100.247.000</b> GBP 19.50
2 slotted partitions: 36E 10 dividers: 9E	

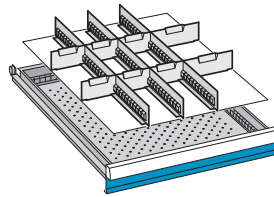

## Dividers

For front height mm	
50	<b>100.249.000</b> GBP 12.30
75	<b>100.250.000</b> GBP 13.80
100, 125	<b>100.251.000</b> GBP 18.00
150	<b>100.252.000</b> GBP 21.80
3 slotted partitions: 36E 6 dividers: 6E 2 dividers: 9E	

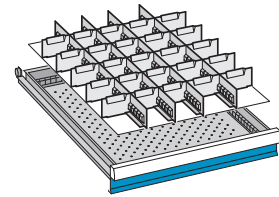

## Dividers

For front height mm	
50	<b>100.234.000</b> GBP 21.80
75	<b>100.235.000</b> GBP 25.50
100, 125	<b>100.236.000</b> GBP 33.00
4 slotted partitions: 36E 15 dividers: 5E 10 dividers: 6E	

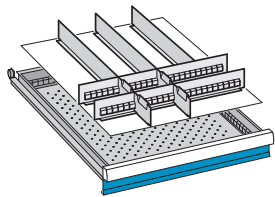

## Dividers

For front height mm	
50	<b>100.254.000</b> GBP 11.50
75	<b>100.255.000</b> GBP 13.00
100, 125	<b>100.256.000</b> GBP 17.00
150	<b>100.257.000</b> GBP 20.50
2 slotted partitions: 27E 4 dividers: 6E 3 plain partitions: 24E	

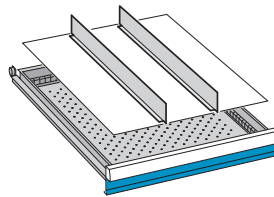

## Dividers

For front height mm	
75	<b>100.265.000</b> GBP 3.80
100, 125	<b>100.266.000</b> GBP 4.90
150	<b>100.267.000</b> GBP 6.00
200	<b>100.268.000</b> GBP 7.50
250	<b>80.695.000</b> GBP 9.30
2 plain partitions: 36E	

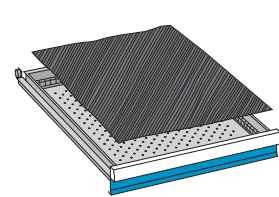

## Anti-slide mat

Designation	
Anti-slide mat anthracite	<b>100.396.000</b> GBP 4.50
Coating: special soft PVC foam. Extremely hardwearing and tear-proof.	

## Partition material Lista Premium

Useable drawer dimension 459 x 612 mm (27 x 36E)

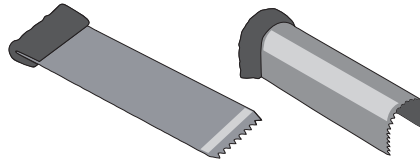
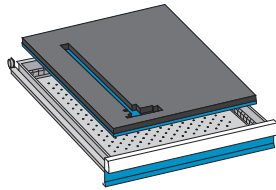

### PE plastic foam inserts

Designation	
Plastic foam insert, black. Thickness 25 mm	<b>80.917.000</b> GBP 15.30
Underlay blue. Thickness 5 mm	<b>80.906.000</b> GBP 10.00

Pre-cut inserts for the most popular tool sets on page 149.

### Plunge cutters

Designation	
Plunge cutter 20 mm	<b>80.920.000</b> GBP 2.60
Plunge cutter 50 mm	<b>80.921.000</b> GBP 4.80
Plunge cutter "U" 20 x 20 mm	<b>80.922.000</b> GBP 9.00

Plunge cutter for PE plastic foam inserts.

### Lista Script labels for partition material

Label size mm	Used for	Number	
47 x 18	Plastic boxes, clip-on label holders	2 sheets (A4), 52 labels each	<b>18.785.000</b> GBP 1.60
47 x 12	Plastic boxes, clip-on label holders	2 sheets (A4), 76 labels each	<b>18.786.000</b> GBP 1.60
27 x 12	Plastic boxes, clip-on label holders	2 sheets (A4), 133 labels each	<b>18.787.000</b> GBP 1.60

### Lista Script labels for cabinet labelling

Label size mm	Used for	Number	
210 x 22 / 70 x 22	Drawer handle, drawer cabinet	5 sheets (A4), 10/30 labels each	<b>18.784.000</b> GBP 2.60

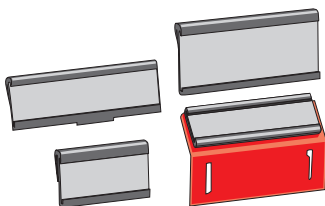

### Clip-on label holders for partition material

Label size mm	Used for	Number	
27 x 12	Trough dividers, dividers, etc.	20 clip-on label holder, 266 labels	<b>134.029.000</b> GBP 7.30
47 x 12	Plastic boxes	20 label holders red	<b>134.034.000</b> GBP 6.80
47 x 12	Dividers, etc.	20 clip-on label holder, 152 labels	<b>134.049.000</b> GBP 7.30
47 x 18	Dividers, etc.	20 clip-on label holder, 104 labels	<b>134.052.000</b> GBP 7.30

## Lista Premium drawer cabinets

Width 717 mm, depth 572 mm (36 x 27E)

### Configuration examples



## Lista Premium drawer cabinets

Width 717 mm, depth 572 mm (36 x 27E)

**Configuration instructions: this is how to put your drawer cabinet together.**

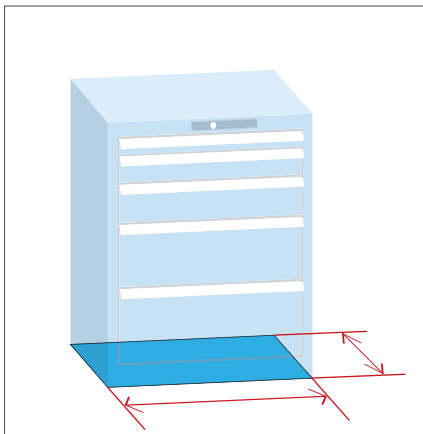

### 1. Selection of the cabinet base area

The first step is the selection of the cabinet base area. It can be indicated in millimetres (width x depth) or Lista units (E x E). The measurements E x E indicate which drawers match which housings.

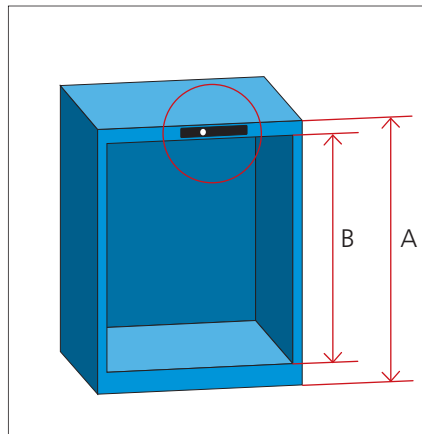

### 2. Selection of housing and locking system

After selecting a base area you can specify the housing. Different heights are available for every floor plan. The selection of housing always includes the choice of the desired locking system and colour.

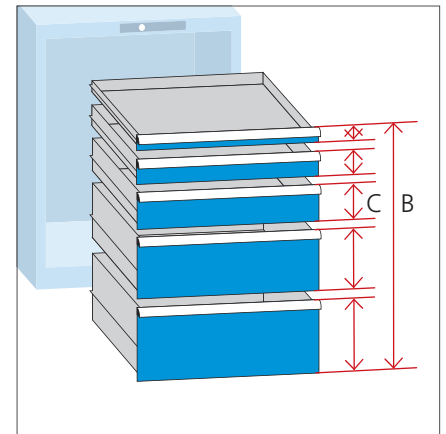

### 3. Selection of drawers

Determine the front height, carrying capacity, and colour of the drawers. The sum total of the front heights C must correspond to the clear height B (refer to figure in point 2). Please also select the type of safety catch.



### 4. Selection of accessories

The drawer cabinet can be combined with cover, base, wheels and push handle for mobile cabinets. Mobile cabinets must be fitted with a drawer safety catch.

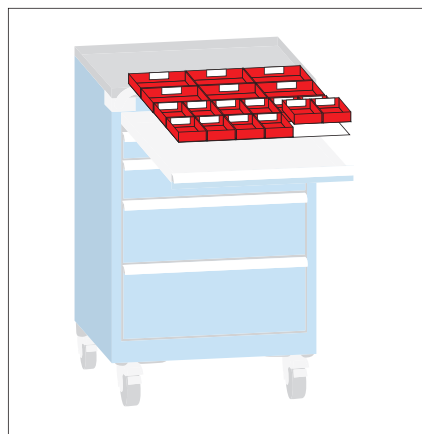

### 5. Selection of partition material

Partition material for drawers is usually ordered as a set. The available selection is large. Please note: The partition material must match the drawer height and useable dimension.

### 6. Determination of the price

The price of the drawer cabinet corresponds to the sum of all selected elements in the corresponding configuration.

# Drawer cabinets Lista Premium

## Width 717 mm, depth 572 mm (36 x 27E)

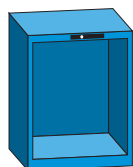

### Housing

Height mm	Clear height mm	Key Lock	Code Lock	Remote Lock	Remote Lock Mobile	Lock without cylinder
700	600	<b>71.086.XXX</b> GBP 198.00	<b>71.145.XXX</b> GBP 238.00	<b>71.204.XXX</b> GBP 353.00	<b>71.255.XXX</b> GBP 423.00	<b>71.027.XXX</b> GBP 189.00
850	750	<b>71.087.XXX</b> GBP 217.00	<b>71.146.XXX</b> GBP 257.00	<b>71.205.XXX</b> GBP 372.00	<b>71.256.XXX</b> GBP 442.00	<b>71.028.XXX</b> GBP 208.00
1000	900	<b>71.088.XXX</b> GBP 238.00	<b>71.147.XXX</b> GBP 278.00	<b>71.206.XXX</b> GBP 393.00	<b>71.257.XXX</b> GBP 463.00	<b>71.029.XXX</b> GBP 229.00
1450	1350	<b>71.089.XXX</b> GBP 296.00	<b>71.148.XXX</b> GBP 336.00	<b>71.207.XXX</b> GBP 451.00		<b>71.030.XXX</b> GBP 287.00

### Accessories Remote Lock

Designation	
Hand-held radio transmitter	<b>74.092.000</b> GBP 23.00
Programming key	<b>74.093.000</b> GBP 33.00
Adapter	<b>74.094.000</b> GBP 33.00
Extension unit 2-pole, 1850 mm	<b>74.098.000</b> GBP 23.00
Extension unit 4-pole, 1850 mm	<b>74.099.000</b> GBP 25.00

### Accessories drawer cabinet without cylinder

Designation	
Cylinder 2C 1 simultaneously lockable	<b>222.377.000</b> GBP 11.00
Cylinder 2C 2 simultaneously lockable	<b>222.378.000</b> GBP 11.00
Cylinder 2C 3 simultaneously lockable	<b>222.379.000</b> GBP 11.00
Cylinder 2C 4 simultaneously lockable	<b>222.380.000</b> GBP 11.00
Cylinder 2C 5 simultaneously lockable	<b>222.381.000</b> GBP 11.00
Cylinder 2C 6 simultaneously lockable	<b>222.382.000</b> GBP 11.00
Cylinder 2C _ simultaneously lockable	<b>222.383.000</b> GBP 12.00
Cylinder main locking system	<b>222.384.000</b> GBP 16.00

### The Lista housing locks

#### Key Lock

Standard closure with central locking system and Lista cylinder lock, individual lock, with 2 keys.

#### Code Lock

Electronic locking system, a number combination replaces the key. Programmable user codes allow a flexible locking system to be created. Battery powered.

#### Remote Lock

Electronic locking system with hand-held radio transmitter (unlocking through radio pulse). A programming key grants access and authorisation. Interlinking of cabinets possible using interlink elements. Connects to main supply (adapter necessary). Please note: hand-held radio transmitter, programming key and adapter not included. Can be ordered optionally if required.

#### Remote Lock Mobile

Same functionality as Remote Lock, but with rechargeable battery (requirement for mobile model). Hand-held radio transmitter and programming key not included. Can be ordered optionally if required.

#### Lock without cylinder

Lock to be included in complete locking systems (simultaneously or main locking systems). For cylinders ordered with predefined lock numbers (2C 1 – 2C 6) or a freely defined number (2C \_). Should a cylinder not be ordered, the housing will be supplied with a lock cover.

For further information on locking systems see page 17.

### The Lista standard colours (without extra charge)

Please complete the last 3 digits of your product code (.XXX) with the desired colour code.

<b>.010</b>	<b>.020</b>	<b>.030</b>	<b>.040</b>	<b>.050</b>	<b>.060</b>	<b>.070</b>	<b>.080</b>	<b>.090</b>	<b>.100</b>
Light blue RAL 5012	Light grey RAL 7035	Reseda green RAL 6011	Capri blue RAL 5019	Grey metallic NCS S 6502-B	Black NCS S 9000-N	Ruby red RAL 3003	Pigeon grey NCS S 4502-B	Gentian blue RAL 5010	Signal blue RAL 5005

# Drawers Lista Premium

Useable drawer dimension 612 x 459 mm (36 x 27E)

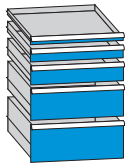

## Drawers 75 kg

Front height mm (useable height)	Standard	Safety catch on the right	Safety catch on the right and left	Double safety catch	Lilo locking device
50 (29)	<b>72.042.XXX</b> GBP 59.00	<b>72.152.XXX</b> GBP 60.00	<b>72.262.XXX</b> GBP 61.00	<b>72.372.XXX</b> GBP 79.00	
75 (54)	<b>72.043.XXX</b> GBP 61.00	<b>72.153.XXX</b> GBP 62.00	<b>72.263.XXX</b> GBP 63.00	<b>72.373.XXX</b> GBP 81.00	
100 (79)	<b>72.045.XXX</b> GBP 64.00	<b>72.155.XXX</b> GBP 65.00	<b>72.265.XXX</b> GBP 66.00	<b>72.375.XXX</b> GBP 84.00	
125 (104)	<b>72.047.XXX</b> GBP 65.00	<b>72.157.XXX</b> GBP 66.00	<b>72.267.XXX</b> GBP 67.00	<b>72.377.XXX</b> GBP 85.00	
150 (129)	<b>72.049.XXX</b> GBP 67.00	<b>72.159.XXX</b> GBP 68.00	<b>72.269.XXX</b> GBP 69.00	<b>72.379.XXX</b> GBP 87.00	
200 (179)	<b>72.051.XXX</b> GBP 75.00	<b>72.161.XXX</b> GBP 76.00	<b>72.271.XXX</b> GBP 77.00	<b>72.381.XXX</b> GBP 95.00	
250 (229)	<b>72.053.XXX</b> GBP 80.00	<b>72.163.XXX</b> GBP 81.00	<b>72.273.XXX</b> GBP 82.00	<b>72.383.XXX</b> GBP 100.00	
300 (279)	<b>72.055.XXX</b> GBP 88.00	<b>72.165.XXX</b> GBP 89.00	<b>72.275.XXX</b> GBP 90.00	<b>72.385.XXX</b> GBP 108.00	

## Drawers 200 kg

Front height mm (useable height)	Standard	Safety catch on the right	Safety catch on the right and left	Double safety catch	Lilo locking device
75 (54)	<b>72.044.XXX</b> GBP 81.00	<b>72.154.XXX</b> GBP 82.00	<b>72.264.XXX</b> GBP 83.00	<b>72.374.XXX</b> GBP 101.00	<b>72.454.XXX</b> GBP 106.00
100 (79)	<b>72.046.XXX</b> GBP 84.00	<b>72.156.XXX</b> GBP 85.00	<b>72.266.XXX</b> GBP 86.00	<b>72.376.XXX</b> GBP 104.00	<b>72.455.XXX</b> GBP 109.00
125 (104)	<b>72.048.XXX</b> GBP 85.00	<b>72.158.XXX</b> GBP 86.00	<b>72.268.XXX</b> GBP 87.00	<b>72.378.XXX</b> GBP 105.00	<b>72.456.XXX</b> GBP 110.00
150 (129)	<b>72.050.XXX</b> GBP 87.00	<b>72.160.XXX</b> GBP 88.00	<b>72.270.XXX</b> GBP 89.00	<b>72.380.XXX</b> GBP 107.00	<b>72.457.XXX</b> GBP 112.00
200 (179)	<b>72.052.XXX</b> GBP 95.00	<b>72.162.XXX</b> GBP 96.00	<b>72.272.XXX</b> GBP 97.00	<b>72.382.XXX</b> GBP 115.00	<b>72.458.XXX</b> GBP 120.00
250 (229)	<b>72.054.XXX</b> GBP 100.00	<b>72.164.XXX</b> GBP 101.00	<b>72.274.XXX</b> GBP 102.00	<b>72.384.XXX</b> GBP 120.00	<b>72.459.XXX</b> GBP 125.00
300 (279)	<b>72.056.XXX</b> GBP 108.00	<b>72.166.XXX</b> GBP 109.00	<b>72.276.XXX</b> GBP 110.00	<b>72.386.XXX</b> GBP 128.00	<b>72.460.XXX</b> GBP 133.00

## The Lista drawer safety catch

### Standard

Standard model without drawer-locking facility.

### Safety catch on the right

Mobile cabinets must be fitted with a drawer safety catch. Prevents unintended opening of drawers even when the cabinet is not locked.

### Safety catch on the right and left as well as double safety catch

Increased safety for use on mobile equipment. Safety catch right and left, operated with both hands. Double catch centrally operated with one hand.

### Lilo locking device

The Lilo locking device (Lock-in – Lock-out) blocks the drawer in an open or closed state. A significant security and comfort benefit, especially for heavy loads.

## The Lista standard colours (without extra charge)

Please complete the last 3 digits of your product code (.XXX) with the desired colour code.

<b>.010</b>	<b>.020</b>	<b>.030</b>	<b>.040</b>	<b>.050</b>	<b>.060</b>	<b>.070</b>	<b>.080</b>	<b>.090</b>	<b>.100</b>
Light blue RAL 5012	Light grey RAL 7035	Reseda green RAL 6011	Capri blue RAL 5019	Grey metallic NCS S 6502-B	Black NCS S 9000-N	Ruby red RAL 3003	Pigeon grey NCS S 4502-B	Gentian blue RAL 5010	Signal blue RAL 5005

## Housing accessories Lista Premium

### Width 717 mm, depth 572 mm (36 x 27E)

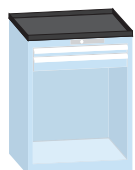

#### Cover

Available with or without raised edging. Colour: black.

##### Designation

Ribbed mat, single, black	<b>74.016.000</b> GBP 18.00
Retainer top with raised edges, 3-sided, incl. ribbed mat (black)	<b>74.027.000</b> GBP 53.00



#### Base

To adjust the height. Colour: black.

Liftable base: This allows the cabinet to be moved with a forklift truck. Colour: black.

##### Designation

Housing base, black, height 50 mm	<b>74.053.000</b> GBP 38.00
Housing base, black, height 100 mm	<b>74.054.000</b> GBP 40.00
Liftable housing base, black, height 100 mm	<b>74.061.000</b> GBP 55.00
Base cover, black, for liftable base	<b>74.066.000</b> GBP 14.00

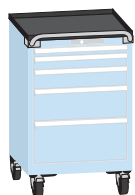

#### Mobile model

Raised edging, 4-sided, incl. ribbed mat (black), 2 swivel castors with brakes, 2 fixed castors, max. load capacity 400 kg, with either nylon or rubber wheels, 1 push handle.

##### Designation

Retainer top with raised edges, 4-sided, incl. ribbed mat (black) and push handle	<b>74.038.000</b> GBP 77.00
Pair of castor supports, with nylon roller set ø 100 mm	<b>74.077.000</b> GBP 62.00
Pair of castor supports, with rubber roller set ø 100 mm	<b>74.078.000</b> GBP 82.00
Pair of castor supports, with rubber roller set ø 160 mm	<b>74.079.000</b> GBP 128.00

# Partition material Lista Premium

Useable drawer dimension 612 x 459 mm (36 x 27E)

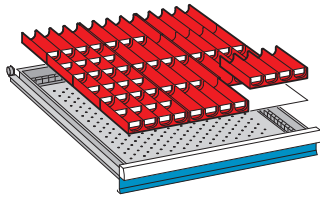

## Troughs

For front height mm	
50	<b>100.283.000</b> GBP 33.50
12 trough-shaped parts: 4 grooves 50 trough dividers: 4 grooves	

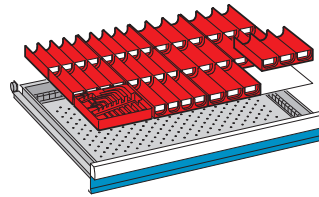

## Troughs

For front height mm	
50	<b>100.312.000</b> GBP 32.50
5 trough-shaped parts: 4 grooves 20 trough dividers: 4 grooves 6 trough-shaped parts: 3 grooves 20 trough dividers: 3 grooves 1 Allen key insert	

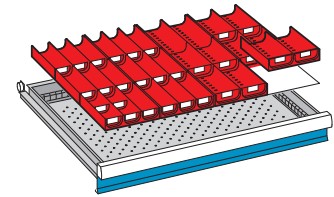

## Troughs

For front height mm	
50	<b>100.313.000</b> GBP 27.50
6 trough-shaped parts: 3 grooves 20 trough dividers: 3 grooves 6 trough-shaped parts: 2 grooves 10 trough dividers: 2 grooves	

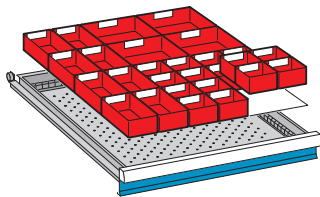

## Plastic boxes

For front height mm	
50	<b>100.290.000</b> GBP 24.80
75	<b>100.291.000</b> GBP 31.00
16 plastic boxes: 75 x 75 mm 8 plastic boxes: 150 x 75 mm 4 plastic boxes: 150 x 150 mm	

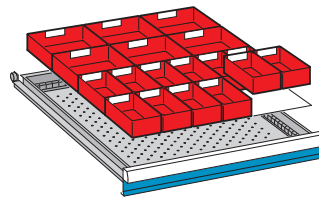

## Plastic boxes

For front height mm	
50	<b>100.292.000</b> GBP 19.80
75	<b>100.293.000</b> GBP 25.50
100, 125	<b>100.294.000</b> GBP 39.50
12 plastic boxes: 150 x 75 mm 6 plastic boxes: 150 x 150 mm	

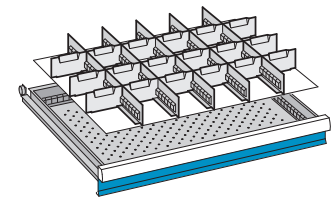

## Dividers

For front height mm	
50	<b>100.950.000</b> GBP 21.50
75	<b>100.951.000</b> GBP 24.30
100, 125	<b>100.952.000</b> GBP 32.00
150	<b>100.953.000</b> GBP 38.50
5 slotted partitions: 27E 18 dividers: 6E	

# Partition material Lista Premium

Useable drawer dimension 612 x 459 mm (36 x 27E)

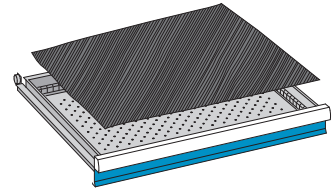
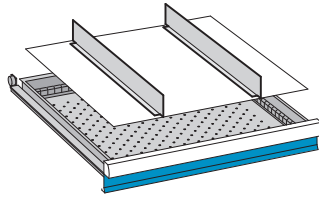
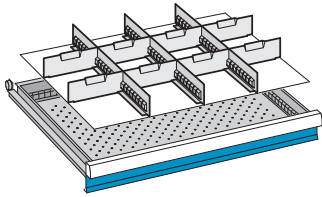

## Dividers

For front height mm	
50	<b>80.649.000</b> GBP 12.80
75	<b>100.314.000</b> GBP 14.30
100, 125	<b>80.651.000</b> GBP 18.80
150	<b>80.652.000</b> GBP 22.00
200	<b>80.653.000</b> GBP 27.50
250	<b>80.654.000</b> GBP 32.00

3 slotted partitions: 27E  
8 dividers: 9E

## Dividers

For front height mm	
75	<b>100.315.000</b> GBP 3.60
100, 125	<b>100.130.000</b> GBP 4.50
150	<b>100.131.000</b> GBP 5.80
200	<b>100.132.000</b> GBP 7.30
250	<b>100.133.000</b> GBP 8.80

2 plain partitions: 27E

## Anti-slide mat

Designation	
Anti-slide mat anthracite	<b>100.396.000</b> GBP 4.50

Coating: special soft PVC foam.  
Extremely hardwearing and tear-proof.

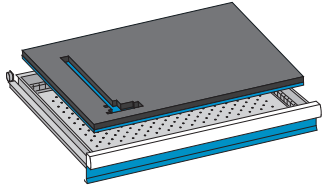

## PE plastic foam inserts

Designation	
Plastic foam insert, black. Thickness 25 mm	<b>80.917.000</b> GBP 15.30
Underlay blue. Thickness 5 mm	<b>80.906.000</b> GBP 10.00

Pre-cut inserts for the most popular tool sets on page 149.

## Plunge cutters

Designation	
Plunge cutter 20 mm	<b>80.920.000</b> GBP 2.60
Plunge cutter 50 mm	<b>80.921.000</b> GBP 4.80
Plunge cutter "U" 20 x 20 mm	<b>80.922.000</b> GBP 9.00

Plunge cutter for PE plastic foam inserts.

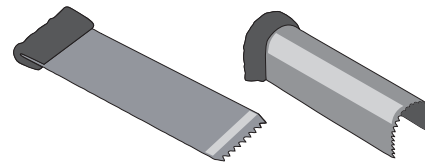

## Partition material Lista Premium

Useable drawer dimension 612 x 459 mm (36 x 27E)

### Lista Script labels for partition material

Label size mm	Used for	Number	
47 x 18	Plastic boxes, clip-on label holders	2 sheets (A4), 52 labels each	<b>18.785.000</b> GBP 1.60
47 x 12	Plastic boxes, clip-on label holders	2 sheets (A4), 76 labels each	<b>18.786.000</b> GBP 1.60
27 x 12	Plastic boxes, clip-on label holders	2 sheets (A4), 133 labels each	<b>18.787.000</b> GBP 1.60

### Lista Script labels for cabinet labelling

Label size mm	Used for	Number	
210 x 22 / 70 x 22	Drawer handle, drawer cabinet	5 sheets (A4), 10/30 labels each	<b>18.784.000</b> GBP 2.60

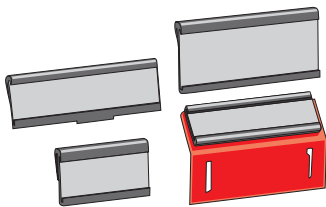

### Clip-on label holders for partition material

Label size mm	Used for	Number	
27 x 12	Trough dividers, dividers, etc.	20 clip-on label holder, 266 labels	<b>134.029.000</b> GBP 7.30
47 x 12	Plastic boxes	20 label holders red	<b>134.034.000</b> GBP 6.80
47 x 12	Dividers, etc.	20 clip-on label holder, 152 labels	<b>134.049.000</b> GBP 7.30
47 x 18	Dividers, etc.	20 clip-on label holder, 104 labels	<b>134.052.000</b> GBP 7.30

## Lista Premium drawer cabinets

Width 717 mm, depth 725 mm (36 x 36E)

### Configuration examples



## Lista Premium drawer cabinets

Width 717 mm, depth 725 mm (36 x 36E)

**Configuration instructions: this is how to put your drawer cabinet together.**

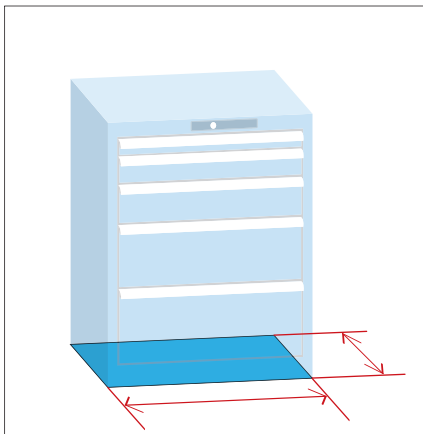

### 1. Selection of the cabinet base area

The first step is the selection of the cabinet base area. It can be indicated in millimetres (width x depth) or Lista units (E x E). The measurements E x E indicate which drawers match which housings.

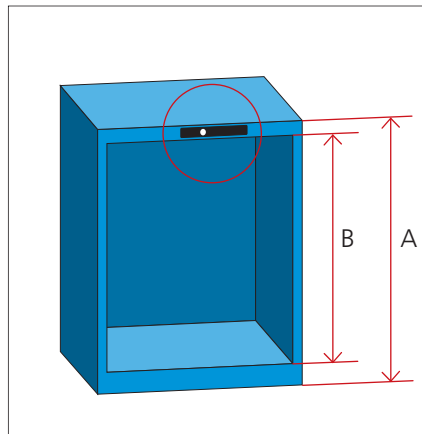

### 2. Selection of housing and locking system

After selecting a base area you can specify the housing. Different heights are available for every floor plan. The selection of housing always includes the choice of the desired locking system and colour.

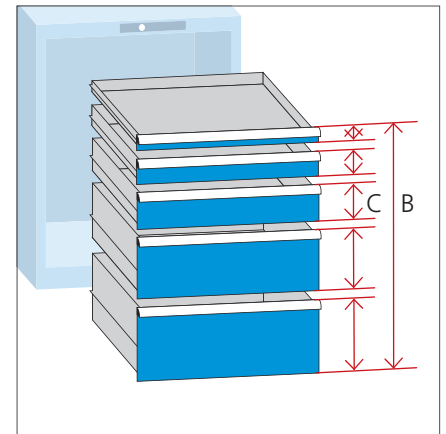

### 3. Selection of drawers

Determine the front height, carrying capacity, and colour of the drawers. The sum total of the front heights C must correspond to the clear height B (refer to figure in point 2). Please also select the type of safety catch.



### 4. Selection of accessories

The drawer cabinet can be combined with cover, base, wheels and push handle for mobile cabinets. Mobile cabinets must be fitted with a drawer safety catch.

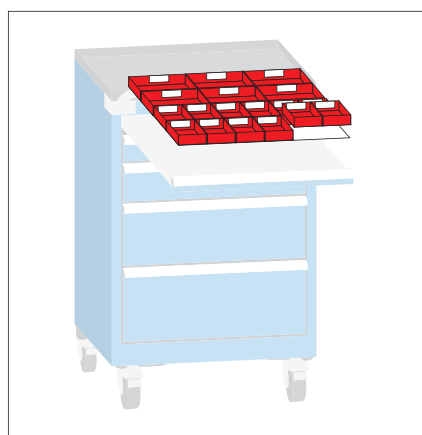

### 5. Selection of partition material

Partition material for drawers is usually ordered as a set. The available selection is large. Please note: The partition material must match the drawer height and useable dimension.

### 6. Determination of the price

The price of the drawer cabinet corresponds to the sum of all selected elements in the corresponding configuration.

# Drawer cabinets Lista Premium

## Width 717 mm, depth 725 mm (36 x 36E)

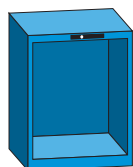

### Housing

Height mm	Clear height mm	Key Lock	Code Lock	Remote Lock	Remote Lock Mobile	Lock without cylinder
700	600	<b>71.090.XXX</b> GBP 210.00	<b>71.149.XXX</b> GBP 250.00	<b>71.208.XXX</b> GBP 365.00	<b>71.258.XXX</b> GBP 435.00	<b>71.031.XXX</b> GBP 201.00
800	700	<b>71.091.XXX</b> GBP 220.00	<b>71.150.XXX</b> GBP 260.00	<b>71.209.XXX</b> GBP 375.00	<b>71.259.XXX</b> GBP 445.00	<b>71.032.XXX</b> GBP 211.00
850	750	<b>71.092.XXX</b> GBP 229.00	<b>71.151.XXX</b> GBP 269.00	<b>71.210.XXX</b> GBP 384.00	<b>71.260.XXX</b> GBP 454.00	<b>71.033.XXX</b> GBP 220.00
1000	900	<b>71.093.XXX</b> GBP 246.00	<b>71.152.XXX</b> GBP 286.00	<b>71.211.XXX</b> GBP 401.00	<b>71.261.XXX</b> GBP 471.00	<b>71.034.XXX</b> GBP 237.00
1150	1050	<b>71.094.XXX</b> GBP 277.00	<b>71.153.XXX</b> GBP 317.00	<b>71.212.XXX</b> GBP 432.00		<b>71.035.XXX</b> GBP 268.00
1325	1225	<b>71.095.XXX</b> GBP 291.00	<b>71.154.XXX</b> GBP 331.00	<b>71.213.XXX</b> GBP 446.00		<b>71.036.XXX</b> GBP 282.00
1450	1350	<b>71.096.XXX</b> GBP 309.00	<b>71.155.XXX</b> GBP 349.00	<b>71.214.XXX</b> GBP 464.00		<b>71.037.XXX</b> GBP 300.00
1625	1525	<b>71.097.XXX</b> GBP 339.00	<b>71.156.XXX</b> GBP 379.00	<b>71.215.XXX</b> GBP 494.00		<b>71.038.XXX</b> GBP 330.00

### Accessories Remote Lock

Designation	
Hand-held radio transmitter	<b>74.092.000</b> GBP 23.00
Programming key	<b>74.093.000</b> GBP 33.00
Adapter	<b>74.094.000</b> GBP 33.00
Extension unit 2-pole, 1850 mm	<b>74.098.000</b> GBP 23.00
Extension unit 4-pole, 1850 mm	<b>74.099.000</b> GBP 25.00

### Accessories drawer cabinet without cylinder

Designation	
Cylinder 2C 1 simultaneously lockable	<b>222.377.000</b> GBP 11.00
Cylinder 2C 2 simultaneously lockable	<b>222.378.000</b> GBP 11.00
Cylinder 2C 3 simultaneously lockable	<b>222.379.000</b> GBP 11.00
Cylinder 2C 4 simultaneously lockable	<b>222.380.000</b> GBP 11.00
Cylinder 2C 5 simultaneously lockable	<b>222.381.000</b> GBP 11.00
Cylinder 2C 6 simultaneously lockable	<b>222.382.000</b> GBP 11.00
Cylinder 2C _ simultaneously lockable	<b>222.383.000</b> GBP 12.00
Cylinder main locking system	<b>222.384.000</b> GBP 16.00

### The Lista housing locks

#### Key Lock

Standard closure with central locking system and Lista cylinder lock, individual lock, with 2 keys.

#### Code Lock

Electronic locking system, a number combination replaces the key. Programmable user codes allow a flexible locking system to be created. Battery powered.

#### Remote Lock

Electronic locking system with hand-held radio transmitter (unlocking through radio pulse). A programming key grants access and authorisation. Interlinking of cabinets possible using interlink elements. Connects to main supply (adapter necessary). Please note: hand-held radio transmitter, programming key and adapter not included. Can be ordered optionally if required.

#### Remote Lock Mobile

Same functionality as Remote Lock, but with rechargeable battery (requirement for mobile model). Hand-held radio transmitter and programming key not included. Can be ordered optionally if required.

#### Lock without cylinder

Lock to be included in complete locking systems (simultaneously or main locking systems). For cylinders ordered with predefined lock numbers (2C 1 – 2C 6) or a freely defined number (2C \_). Should a cylinder not be ordered, the housing will be supplied with a lock cover.

For further information on locking systems see page 17.

### The Lista standard colours (without extra charge)

Please complete the last 3 digits of your product code (.XXX) with the desired colour code.

<b>.010</b>	<b>.020</b>	<b>.030</b>	<b>.040</b>	<b>.050</b>	<b>.060</b>	<b>.070</b>	<b>.080</b>	<b>.090</b>	<b>.100</b>
Light blue RAL 5012	Light grey RAL 7035	Reseda green RAL 6011	Capri blue RAL 5019	Grey metallic NCS S 6502-B	Black NCS S 9000-N	Ruby red RAL 3003	Pigeon grey NCS S 4502-B	Gentian blue RAL 5010	Signal blue RAL 5005

# Drawers Lista Premium

Useable drawer dimension 612 x 612 mm (36 x 36E)

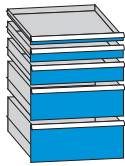

## Drawers 75 kg

Front height mm (useable height)	Standard	Safety catch on the right	Safety catch on the right and left	Double safety catch	Lilo locking device
50 (29)	<b>72.057.XXX</b> GBP 61.00	<b>72.167.XXX</b> GBP 62.00	<b>72.277.XXX</b> GBP 63.00	<b>72.387.XXX</b> GBP 81.00	
75 (54)	<b>72.058.XXX</b> GBP 66.00	<b>72.168.XXX</b> GBP 67.00	<b>72.278.XXX</b> GBP 68.00	<b>72.388.XXX</b> GBP 86.00	
100 (79)	<b>72.060.XXX</b> GBP 69.00	<b>72.170.XXX</b> GBP 70.00	<b>72.280.XXX</b> GBP 71.00	<b>72.390.XXX</b> GBP 89.00	
125 (104)	<b>72.062.XXX</b> GBP 72.00	<b>72.172.XXX</b> GBP 73.00	<b>72.282.XXX</b> GBP 74.00	<b>72.392.XXX</b> GBP 92.00	
150 (129)	<b>72.064.XXX</b> GBP 74.00	<b>72.174.XXX</b> GBP 75.00	<b>72.284.XXX</b> GBP 76.00	<b>72.394.XXX</b> GBP 94.00	
200 (179)	<b>72.066.XXX</b> GBP 84.00	<b>72.176.XXX</b> GBP 85.00	<b>72.286.XXX</b> GBP 86.00	<b>72.396.XXX</b> GBP 104.00	
250 (229)	<b>72.068.XXX</b> GBP 98.00	<b>72.178.XXX</b> GBP 99.00	<b>72.288.XXX</b> GBP 100.00	<b>72.398.XXX</b> GBP 118.00	
300 (279)	<b>72.070.XXX</b> GBP 105.00	<b>72.180.XXX</b> GBP 106.00	<b>72.290.XXX</b> GBP 107.00	<b>72.400.XXX</b> GBP 125.00	

## Drawers 200 kg

Front height mm (useable height)	Standard	Safety catch on the right	Safety catch on the right and left	Double safety catch	Lilo locking device
75 (54)	<b>72.059.XXX</b> GBP 86.00	<b>72.169.XXX</b> GBP 87.00	<b>72.279.XXX</b> GBP 88.00	<b>72.389.XXX</b> GBP 106.00	<b>72.461.XXX</b> GBP 111.00
100 (79)	<b>72.061.XXX</b> GBP 89.00	<b>72.171.XXX</b> GBP 90.00	<b>72.281.XXX</b> GBP 91.00	<b>72.391.XXX</b> GBP 109.00	<b>72.462.XXX</b> GBP 114.00
125 (104)	<b>72.063.XXX</b> GBP 92.00	<b>72.173.XXX</b> GBP 93.00	<b>72.283.XXX</b> GBP 94.00	<b>72.393.XXX</b> GBP 112.00	<b>72.463.XXX</b> GBP 117.00
150 (129)	<b>72.065.XXX</b> GBP 94.00	<b>72.175.XXX</b> GBP 95.00	<b>72.285.XXX</b> GBP 96.00	<b>72.395.XXX</b> GBP 114.00	<b>72.464.XXX</b> GBP 119.00
200 (179)	<b>72.067.XXX</b> GBP 104.00	<b>72.177.XXX</b> GBP 105.00	<b>72.287.XXX</b> GBP 106.00	<b>72.397.XXX</b> GBP 124.00	<b>72.465.XXX</b> GBP 129.00
250 (229)	<b>72.069.XXX</b> GBP 118.00	<b>72.179.XXX</b> GBP 119.00	<b>72.289.XXX</b> GBP 120.00	<b>72.399.XXX</b> GBP 138.00	<b>72.466.XXX</b> GBP 143.00
300 (279)	<b>72.071.XXX</b> GBP 125.00	<b>72.181.XXX</b> GBP 126.00	<b>72.291.XXX</b> GBP 127.00	<b>72.401.XXX</b> GBP 145.00	<b>72.467.XXX</b> GBP 150.00

## The Lista drawer safety catch

### Standard

Standard model without drawer-locking facility.

### Safety catch on the right

Mobile cabinets must be fitted with a drawer safety catch. Prevents unintended opening of drawers even when the cabinet is not locked.

### Safety catch on the right and left as well as double safety catch

Increased safety for use on mobile equipment. Safety catch right and left, operated with both hands. Double catch centrally operated with one hand.

### Lilo locking device

The Lilo locking device (Lock-in – Lock-out) blocks the drawer in an open or closed state. A significant security and comfort benefit, especially for heavy loads.

## The Lista standard colours (without extra charge)

Please complete the last 3 digits of your product code (.XXX) with the desired colour code.

<b>.010</b>	<b>.020</b>	<b>.030</b>	<b>.040</b>	<b>.050</b>	<b>.060</b>	<b>.070</b>	<b>.080</b>	<b>.090</b>	<b>.100</b>
Light blue RAL 5012	Light grey RAL 7035	Reseda green RAL 6011	Capri blue RAL 5019	Grey metallic NCS S 6502-B	Black NCS S 9000-N	Ruby red RAL 3003	Pigeon grey NCS S 4502-B	Gentian blue RAL 5010	Signal blue RAL 5005

## Housing accessories Lista Premium

Width 717 mm, depth 725 mm (36 x 36E)



### Cover

Available with or without raised edging. Colour: black.

#### Designation

Ribbed mat, single, black	<b>74.017.000</b> GBP 23.00
Retainer top with raised edges, 3-sided, incl. ribbed mat (black)	<b>74.028.000</b> GBP 58.00



### Base

To adjust the height. Colour: black.

Liftable base: This allows the cabinet to be moved with a forklift truck. Colour: black.

#### Designation

Housing base, black, height 50 mm	<b>74.055.000</b> GBP 39.00
Liftable housing base, black, height 100 mm	<b>74.062.000</b> GBP 60.00
Base cover, black, for liftable base	<b>74.066.000</b> GBP 14.00

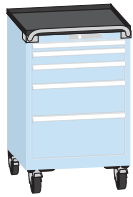

### Mobile model

Raised edging, 4-sided, incl. ribbed mat (black), 2 swivel castors with brakes, 2 fixed castors, max. load capacity 400 kg, with either nylon or rubber wheels, 1 push handle.

#### Designation

Retainer top with raised edges, 4-sided, incl. ribbed mat (black) and push handle	<b>74.039.000</b> GBP 88.00
Pair of castor supports, with nylon roller set ø 100 mm	<b>74.073.000</b> GBP 64.00
Pair of castor supports, with rubber roller set ø 100 mm	<b>74.074.000</b> GBP 85.00
Pair of castor supports, with rubber roller set ø 160 mm	<b>74.076.000</b> GBP 131.00

# Partition material Lista Premium

Useable drawer dimension 612 x 612 mm (36 x 36E)

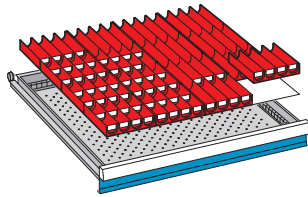

## Troughs

### For front height mm

50	<b>100.317.000</b> GBP 45.50
----	---------------------------------

16 trough-shaped parts:  
4 grooves  
70 trough dividers: 4 grooves

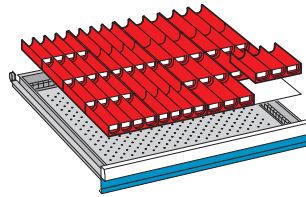

## Troughs

### For front height mm

50	<b>100.318.000</b> GBP 40.00
----	---------------------------------

8 trough-shaped parts: 4 grooves  
30 trough dividers: 4 grooves  
8 trough-shaped parts: 3 grooves  
20 trough dividers: 3 grooves

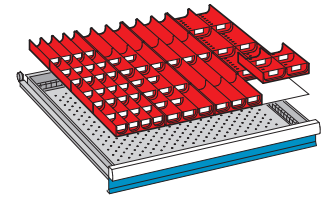

## Troughs

### For front height mm

50	<b>100.319.000</b> GBP 41.50
----	---------------------------------

4 trough-shaped parts: 4 grooves  
30 trough dividers: 4 grooves  
8 trough-shaped parts: 3 grooves  
20 trough dividers: 3 grooves  
4 trough-shaped parts: 2 grooves  
10 trough dividers: 2 grooves

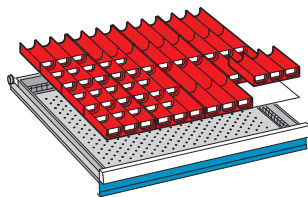

## Troughs

### For front height mm

50	<b>100.320.000</b> GBP 41.50
----	---------------------------------

16 trough-shaped parts:  
3 grooves  
60 trough dividers: 3 grooves

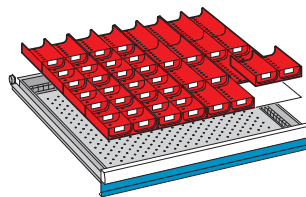

## Troughs

### For front height mm

50	<b>100.322.000</b> GBP 35.50
----	---------------------------------

16 trough-shaped parts:  
2 grooves  
40 trough dividers: 2 grooves

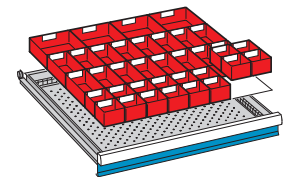

## Plastic boxes

### For front height mm

50	<b>100.380.000</b> GBP 32.00
75	<b>100.381.000</b> GBP 40.50

16 plastic boxes: 75 x 75 mm  
16 plastic boxes: 150 x 75 mm  
4 plastic boxes: 150 x 150 mm

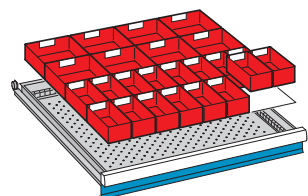

## Plastic boxes

### For front height mm

50	<b>100.389.000</b> GBP 26.50
75	<b>100.390.000</b> GBP 34.00
100, 125	<b>100.391.000</b> GBP 52.50

16 plastic boxes: 150 x 75 mm  
8 plastic boxes: 150 x 150 mm

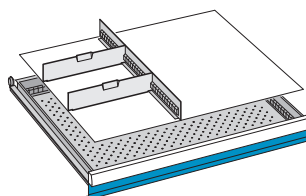

## Dividers

### For front height mm

100, 125	<b>100.354.000</b> GBP 6.30
150	<b>100.355.000</b> GBP 8.30
200	<b>100.356.000</b> GBP 10.30
250	<b>80.688.000</b> GBP 12.30
300	<b>100.357.000</b> GBP 14.00

1 slotted partition: 36E  
2 dividers: 18E

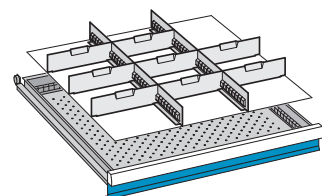

## Dividers

### For front height mm

75	<b>100.348.000</b> GBP 13.00
100, 125	<b>100.349.000</b> GBP 15.80
150	<b>100.350.000</b> GBP 18.80
200	<b>100.351.000</b> GBP 25.00

2 slotted partitions: 36E  
8 dividers: 12E

# Partition material Lista Premium

Useable drawer dimension 612 x 612 mm (36 x 36E)

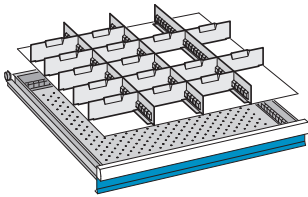

## Dividers

For front height mm	
75	<b>100.343.000</b> GBP 19.80
100, 125	<b>100.344.000</b> GBP 25.50
150	<b>100.345.000</b> GBP 29.50
200	<b>100.346.000</b> GBP 35.50
250	<b>80.689.000</b> GBP 43.00

3 slotted partitions: 36E  
15 dividers: 9E

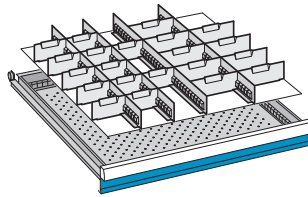

## Dividers

For front height mm	
50	<b>100.333.000</b> GBP 22.00
75	<b>100.334.000</b> GBP 25.50
100, 125	<b>100.335.000</b> GBP 32.50

4 slotted partitions: 36E  
12 dividers: 6E  
9 dividers: 9E

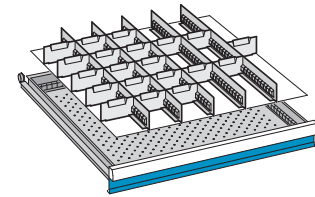

## Dividers

For front height mm	
50	<b>100.329.000</b> GBP 23.00
75	<b>100.330.000</b> GBP 26.50
100, 125	<b>100.331.000</b> GBP 34.00

5 slotted partitions: 36E  
20 dividers: 6E

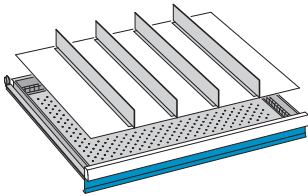

## Dividers

For front height mm	
75	<b>100.368.000</b> GBP 7.50
100, 125	<b>100.369.000</b> GBP 9.80
150	<b>100.370.000</b> GBP 11.80
200	<b>100.371.000</b> GBP 15.00
250	<b>80.690.000</b> GBP 18.30

4 plain partitions: 36E

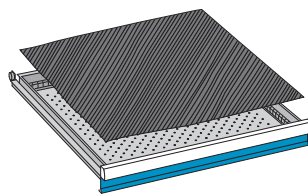

## Anti-slide mat

Designation	
Anti-slide mat anthracite	<b>100.394.000</b> GBP 6.00

Coating: special soft PVC foam.  
Extremely hardwearing and tear-proof.

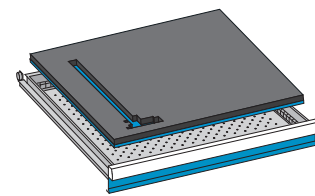

## PE plastic foam inserts

Designation	
Plastic foam insert, black. Thickness 25 mm	<b>80.918.000</b> GBP 20.30
Underlay blue. Thickness 5 mm	<b>80.907.000</b> GBP 13.00

Pre-cut inserts for the most popular tool sets on page 149.

## Partition material Lista Premium

Useable drawer dimension 612 x 612 mm (36 x 36E)

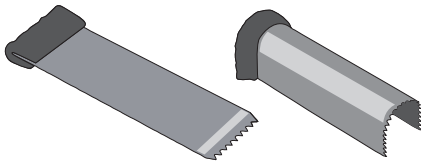

### Plunge cutters

Designation	
Plunge cutter 20 mm	<b>80.920.000</b> GBP 2.60
Plunge cutter 50 mm	<b>80.921.000</b> GBP 4.80
Plunge cutter "U" 20 x 20 mm	<b>80.922.000</b> GBP 9.00
Plunge cutter for PE plastic foam inserts.	

### Lista Script labels for partition material

Label size mm	Used for	Number	
47 x 18	Plastic boxes, clip-on label holders	2 sheets (A4), 52 labels each	<b>18.785.000</b> GBP 1.60
47 x 12	Plastic boxes, clip-on label holders	2 sheets (A4), 76 labels each	<b>18.786.000</b> GBP 1.60
27 x 12	Plastic boxes, clip-on label holders	2 sheets (A4), 133 labels each	<b>18.787.000</b> GBP 1.60

### Lista Script labels for cabinet labelling

Label size mm	Used for	Number	
210 x 22 / 70 x 22	Drawer handle, drawer cabinet	5 sheets (A4), 10/30 labels each	<b>18.784.000</b> GBP 2.60

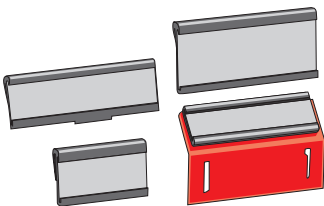

### Clip-on label holders for partition material

Label size mm	Used for	Number	
27 x 12	Trough dividers, dividers, etc.	20 clip-on label holder, 266 labels	<b>134.029.000</b> GBP 7.30
47 x 12	Plastic boxes	20 label holders red	<b>134.034.000</b> GBP 6.80
47 x 12	Dividers, etc.	20 clip-on label holder, 152 labels	<b>134.049.000</b> GBP 7.30
47 x 18	Dividers, etc.	20 clip-on label holder, 104 labels	<b>134.052.000</b> GBP 7.30

## Lista Premium drawer cabinets

Width 870 mm, depth 725 mm (45 x 36E)

### Configuration examples



## Lista Premium drawer cabinets

Width 870 mm, depth 725 mm (45 x 36E)

**Configuration instructions: this is how to put your drawer cabinet together.**

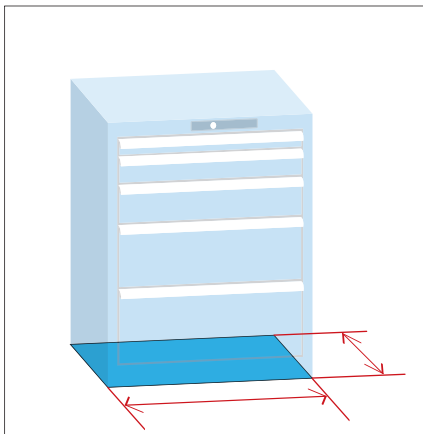

### 1. Selection of the cabinet base area

The first step is the selection of the cabinet base area. It can be indicated in millimetres (width x depth) or Lista units (E x E). The measurements E x E indicate which drawers match which housings.

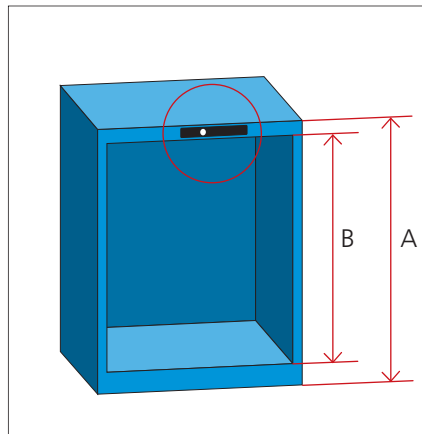

### 2. Selection of housing and locking system

After selecting a base area you can specify the housing. Different heights are available for every floor plan. The selection of housing always includes the choice of the desired locking system and colour.

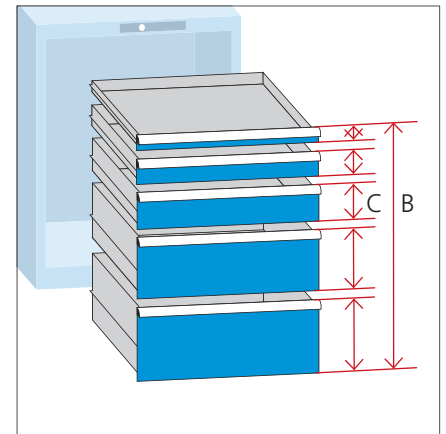

### 3. Selection of drawers

Determine the front height, carrying capacity, and colour of the drawers. The sum total of the front heights C must correspond to the clear height B (refer to figure in point 2). Please also select the type of safety catch.



### 4. Selection of accessories

The drawer cabinet can be combined with cover, base, wheels and push handle for mobile cabinets. Mobile cabinets must be fitted with a drawer safety catch.

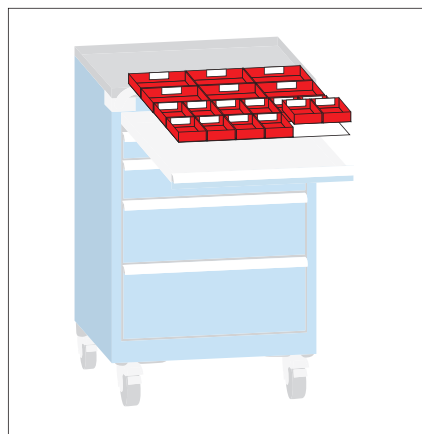

### 5. Selection of partition material

Partition material for drawers is usually ordered as a set. The available selection is large. Please note: The partition material must match the drawer height and useable dimension.

### 6. Determination of the price

The price of the drawer cabinet corresponds to the sum of all selected elements in the corresponding configuration.

# Drawer cabinets Lista Premium

## Width 870 mm, depth 725 mm (45 x 36E)

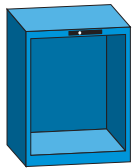

### Housing

Height mm	Clear height mm	Key Lock	Code Lock	Remote Lock	Remote Lock Mobile	Lock without cylinder
700	600	<b>71.098.XXX</b> GBP 264.00	<b>71.157.XXX</b> GBP 304.00	<b>71.216.XXX</b> GBP 419.00	<b>71.262.XXX</b> GBP 489.00	<b>71.039.XXX</b> GBP 255.00
850	750	<b>71.099.XXX</b> GBP 285.00	<b>71.158.XXX</b> GBP 325.00	<b>71.217.XXX</b> GBP 440.00	<b>71.263.XXX</b> GBP 510.00	<b>71.040.XXX</b> GBP 276.00
1000	900	<b>71.100.XXX</b> GBP 297.00	<b>71.159.XXX</b> GBP 337.00	<b>71.218.XXX</b> GBP 452.00	<b>71.264.XXX</b> GBP 522.00	<b>71.041.XXX</b> GBP 288.00
1450	1350	<b>71.101.XXX</b> GBP 355.00	<b>71.160.XXX</b> GBP 395.00	<b>71.219.XXX</b> GBP 510.00		<b>71.042.XXX</b> GBP 336.00

### Accessories Remote Lock

Designation	
Hand-held radio transmitter	<b>74.092.000</b> GBP 23.00
Programming key	<b>74.093.000</b> GBP 33.00
Adapter	<b>74.094.000</b> GBP 33.00
Extension unit 2-pole, 1850 mm	<b>74.098.000</b> GBP 23.00
Extension unit 4-pole, 1850 mm	<b>74.099.000</b> GBP 25.00

### Accessories drawer cabinet without cylinder

Designation	
Cylinder 2C 1 simultaneously lockable	<b>222.377.000</b> GBP 11.00
Cylinder 2C 2 simultaneously lockable	<b>222.378.000</b> GBP 11.00
Cylinder 2C 3 simultaneously lockable	<b>222.379.000</b> GBP 11.00
Cylinder 2C 4 simultaneously lockable	<b>222.380.000</b> GBP 11.00
Cylinder 2C 5 simultaneously lockable	<b>222.381.000</b> GBP 11.00
Cylinder 2C 6 simultaneously lockable	<b>222.382.000</b> GBP 11.00
Cylinder 2C _ simultaneously lockable	<b>222.383.000</b> GBP 12.00
Cylinder main locking system	<b>222.384.000</b> GBP 16.00

### The Lista housing locks

#### Key Lock

Standard closure with central locking system and Lista cylinder lock, individual lock, with 2 keys.

#### Code Lock

Electronic locking system, a number combination replaces the key. Programmable user codes allow a flexible locking system to be created. Battery powered.

#### Remote Lock

Electronic locking system with hand-held radio transmitter (unlocking through radio pulse). A programming key grants access and authorisation. Interlinking of cabinets possible using interlink elements. Connects to main supply (adapter necessary). Please note: hand-held radio transmitter, programming key and adapter not included. Can be ordered optionally if required.

#### Remote Lock Mobile

Same functionality as Remote Lock, but with rechargeable battery (requirement for mobile model). Hand-held radio transmitter and programming key not included. Can be ordered optionally if required.

#### Lock without cylinder

Lock to be included in complete locking systems (simultaneously or main locking systems). For cylinders ordered with predefined lock numbers (2C 1 – 2C 6) or a freely defined number (2C \_). Should a cylinder not be ordered, the housing will be supplied with a lock cover.

For further information on locking systems see page 17.

### The Lista standard colours (without extra charge)

Please complete the last 3 digits of your product code (.XXX) with the desired colour code.

<b>.010</b>	<b>.020</b>	<b>.030</b>	<b>.040</b>	<b>.050</b>	<b>.060</b>	<b>.070</b>	<b>.080</b>	<b>.090</b>	<b>.100</b>
Light blue RAL 5012	Light grey RAL 7035	Reseda green RAL 6011	Capri blue RAL 5019	Grey metallic NCS S 6502-B	Black NCS S 9000-N	Ruby red RAL 3003	Pigeon grey NCS S 4502-B	Gentian blue RAL 5010	Signal blue RAL 5005

# Drawers Lista Premium

Useable drawer dimension 765 x 612 mm (45 x 36E)

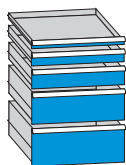

## Drawers 75 kg

Front height mm (useable height)	Standard	Safety catch on the right	Safety catch on the right and left	Double safety catch	Lilo locking device
50 (29)	<b>72.072.XXX</b> GBP 75.00	<b>72.182.XXX</b> GBP 76.00	<b>72.292.XXX</b> GBP 77.00	<b>72.402.XXX</b> GBP 95.00	

## Drawers 200 kg

Front height mm (useable height)	Standard	Safety catch on the right	Safety catch on the right and left	Double safety catch	Lilo locking device
75 (54)	<b>72.073.XXX</b> GBP 105.00	<b>72.183.XXX</b> GBP 106.00	<b>72.293.XXX</b> GBP 107.00	<b>72.403.XXX</b> GBP 125.00	<b>72.468.XXX</b> GBP 130.00
100 (79)	<b>72.074.XXX</b> GBP 108.00	<b>72.184.XXX</b> GBP 109.00	<b>72.294.XXX</b> GBP 110.00	<b>72.404.XXX</b> GBP 128.00	<b>72.469.XXX</b> GBP 133.00
125 (104)	<b>72.075.XXX</b> GBP 112.00	<b>72.185.XXX</b> GBP 113.00	<b>72.295.XXX</b> GBP 114.00	<b>72.405.XXX</b> GBP 132.00	<b>72.470.XXX</b> GBP 137.00
150 (129)	<b>72.076.XXX</b> GBP 116.00	<b>72.186.XXX</b> GBP 117.00	<b>72.296.XXX</b> GBP 118.00	<b>72.406.XXX</b> GBP 136.00	<b>72.471.XXX</b> GBP 141.00
200 (179)	<b>72.077.XXX</b> GBP 123.00	<b>72.187.XXX</b> GBP 124.00	<b>72.297.XXX</b> GBP 125.00	<b>72.407.XXX</b> GBP 143.00	<b>72.472.XXX</b> GBP 148.00
250 (229)	<b>72.078.XXX</b> GBP 130.00	<b>72.188.XXX</b> GBP 131.00	<b>72.298.XXX</b> GBP 132.00	<b>72.408.XXX</b> GBP 150.00	<b>72.473.XXX</b> GBP 155.00
300 (279)	<b>72.079.XXX</b> GBP 142.00	<b>72.189.XXX</b> GBP 143.00	<b>72.299.XXX</b> GBP 144.00	<b>72.409.XXX</b> GBP 162.00	<b>72.474.XXX</b> GBP 167.00

## The Lista drawer safety catch

### Standard

Standard model without drawer-locking facility.

### Safety catch on the right

Mobile cabinets must be fitted with a drawer safety catch. Prevents unintended opening of drawers even when the cabinet is not locked.

### Safety catch on the right and left as well as double safety catch

Increased safety for use on mobile equipment. Safety catch right and left, operated with both hands. Double catch centrally operated with one hand.

### Lilo locking device

The Lilo locking device (Lock-in – Lock-out) blocks the drawer in an open or closed state. A significant security and comfort benefit, especially for heavy loads.

## The Lista standard colours (without extra charge)

Please complete the last 3 digits of your product code (.XXX) with the desired colour code.

<b>.010</b>	<b>.020</b>	<b>.030</b>	<b>.040</b>	<b>.050</b>	<b>.060</b>	<b>.070</b>	<b>.080</b>	<b>.090</b>	<b>.100</b>
Light blue RAL 5012	Light grey RAL 7035	Reseda green RAL 6011	Capri blue RAL 5019	Grey metallic NCS S 6502-B	Black NCS S 9000-N	Ruby red RAL 3003	Pigeon grey NCS S 4502-B	Gentian blue RAL 5010	Signal blue RAL 5005

## Housing accessories Lista Premium

Width 870 mm, depth 725 mm (45 x 36E)



### Cover

Available with or without raised edging. Colour: black.

#### Designation

Ribbed mat, single, black	<b>74.018.000</b> GBP 26.00
Retainer top with raised edges, 3-sided, incl. ribbed mat (black)	<b>74.029.000</b> GBP 68.00



### Base

To adjust the height. Colour: black.

Liftable base: This allows the cabinet to be moved with a forklift truck. Colour: black.

#### Designation

Housing base, black, height 50 mm	<b>74.056.000</b> GBP 41.00
Liftable housing base, black, height 100 mm	<b>74.063.000</b> GBP 68.00
Base cover, black, for liftable base	<b>74.067.000</b> GBP 17.00

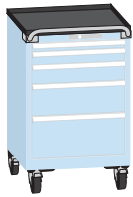

### Mobile model

Raised edging, 4-sided, incl. ribbed mat (black), 2 swivel castors with brakes, 2 fixed castors, max. load capacity 400 kg, with either nylon or rubber wheels, 1 push handle.

#### Designation

Retainer top with raised edges, 4-sided, incl. ribbed mat (black) and push handle	<b>74.040.000</b> GBP 98.00
Pair of castor supports, with nylon roller set ø 100 mm	<b>74.080.000</b> GBP 64.00
Pair of castor supports, with rubber roller set ø 100 mm	<b>74.081.000</b> GBP 85.00
Pair of castor supports, with rubber roller set ø 160 mm	<b>74.082.000</b> GBP 131.00

# Partition material Lista Premium

Useable drawer dimension 765 x 612 mm (45 x 36E)

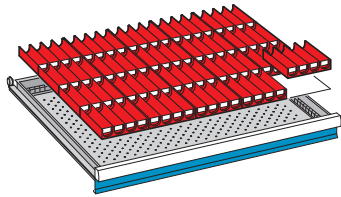

## Troughs

### For front height mm

50	<b>80.490.000</b> GBP 55.00
----	--------------------------------

20 trough-shaped parts:  
4 grooves  
80 trough dividers: 4 grooves

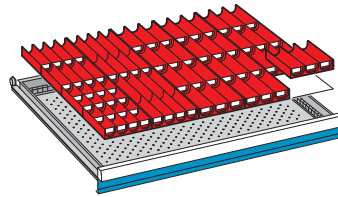

## Troughs

### For front height mm

50	<b>80.491.000</b> GBP 53.50
----	--------------------------------

8 trough-shaped parts: 4 grooves  
40 trough dividers: 4 grooves  
12 trough-shaped parts:  
3 grooves  
40 trough dividers: 3 grooves

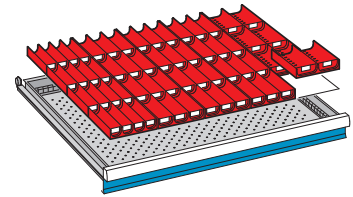

## Troughs

### For front height mm

50	<b>80.492.000</b> GBP 50.50
----	--------------------------------

4 trough-shaped parts: 4 grooves  
20 trough dividers: 4 grooves  
12 trough-shaped parts:  
3 grooves  
40 trough dividers: 3 grooves  
4 trough-shaped parts: 2 grooves  
10 trough dividers: 2 grooves

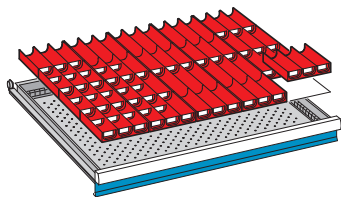

## Troughs

### For front height mm

50	<b>80.493.000</b> GBP 48.50
----	--------------------------------

20 trough-shaped parts:  
3 grooves  
60 trough dividers: 3 grooves

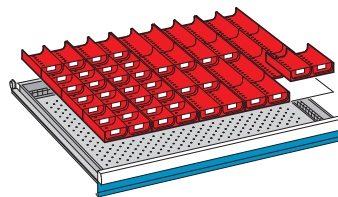

## Troughs

### For front height mm

50	<b>80.494.000</b> GBP 42.00
----	--------------------------------

20 trough-shaped parts:  
2 grooves  
40 trough dividers: 2 grooves

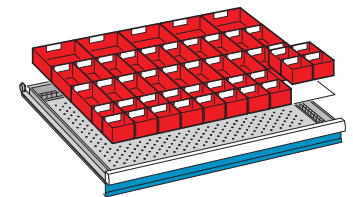

## Plastic boxes

### For front height mm

50	<b>80.496.000</b> GBP 40.00
75	<b>80.497.000</b> GBP 50.50

20 plastic boxes: 75 x 75 mm  
20 plastic boxes: 150 x 75 mm  
5 plastic boxes: 150 x 150 mm

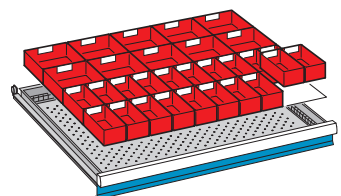

## Plastic boxes

### For front height mm

50	<b>80.498.000</b> GBP 33.00
75	<b>80.499.000</b> GBP 42.00
100, 125	<b>80.500.000</b> GBP 65.50

20 plastic boxes: 150 x 75 mm  
10 plastic boxes: 150 x 150 mm

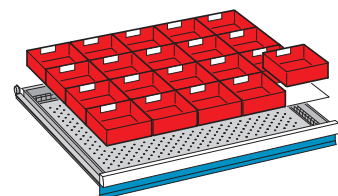

## Plastic boxes

### For front height mm

50	<b>80.501.000</b> GBP 30.50
75	<b>80.502.000</b> GBP 36.50
100, 125	<b>80.503.000</b> GBP 48.00

20 plastic boxes: 150 x 150 mm

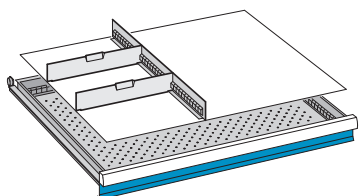

## Dividers

### For front height mm

100, 125	<b>100.354.000</b> GBP 6.30
150	<b>100.355.000</b> GBP 8.30
200	<b>100.356.000</b> GBP 10.30
250	<b>80.688.000</b> GBP 12.30
300	<b>100.357.000</b> GBP 14.00

1 slotted partition: 36E  
2 dividers: 18E

# Partition material Lista Premium

Useable drawer dimension 765 x 612 mm (45 x 36E)

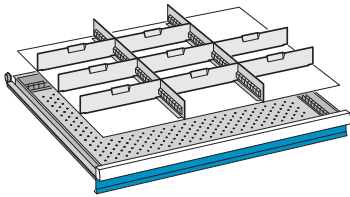

## Dividers

For front height mm	
100, 125	<b>80.504.000</b> GBP 16.00
150	<b>80.505.000</b> GBP 20.50
200	<b>80.506.000</b> GBP 26.50
250	<b>80.507.000</b> GBP 33.00
300	<b>80.508.000</b> GBP 38.00

2 slotted partitions: 36E  
8 dividers: 15E

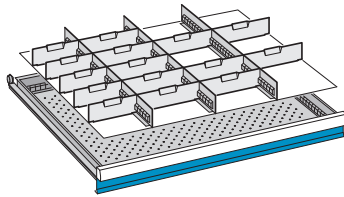

## Dividers

For front height mm	
75	<b>80.509.000</b> GBP 21.50
100, 125	<b>80.510.000</b> GBP 26.00
150	<b>80.511.000</b> GBP 31.00
200	<b>80.512.000</b> GBP 40.00

3 slotted partitions: 36E  
5 dividers: 9E  
10 dividers: 12E

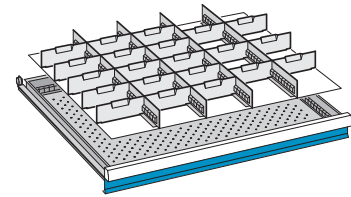

## Dividers

For front height mm	
75	<b>80.513.000</b> GBP 27.50
100, 125	<b>80.514.000</b> GBP 35.00
150	<b>80.515.000</b> GBP 40.00
200	<b>80.516.000</b> GBP 48.50
250	<b>80.517.000</b> GBP 59.00

4 slotted partitions: 36E  
21 dividers: 9E

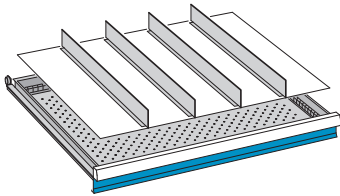

## Dividers

For front height mm	
75	<b>100.368.000</b> GBP 7.50
100, 125	<b>100.369.000</b> GBP 9.80
150	<b>100.370.000</b> GBP 11.80
200	<b>100.371.000</b> GBP 15.00
250	<b>80.690.000</b> GBP 18.30

4 plain partitions: 36E

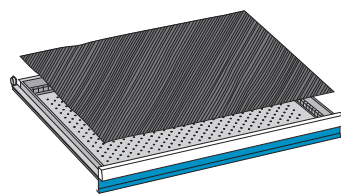

## Anti-slide mat

Designation	
Anti-slide mat anthracite	<b>130.743.000</b> GBP 6.50

Coating: special soft PVC foam.  
Extremely hardwearing and tear-proof.

## Partition material Lista Premium

Useable drawer dimension 765 x 612 mm (45 x 36E)

### Lista Script labels for partition material

Label size mm	Used for	Number	
47 x 18	Plastic boxes, clip-on label holders	2 sheets (A4), 52 labels each	<b>18.785.000</b> GBP 1.60
47 x 12	Plastic boxes, clip-on label holders	2 sheets (A4), 76 labels each	<b>18.786.000</b> GBP 1.60
27 x 12	Plastic boxes, clip-on label holders	2 sheets (A4), 133 labels each	<b>18.787.000</b> GBP 1.60

### Lista Script labels for cabinet labelling

Label size mm	Used for	Number	
210 x 22 / 70 x 22	Drawer handle, drawer cabinet	5 sheets (A4), 10/30 labels each	<b>18.784.000</b> GBP 2.60

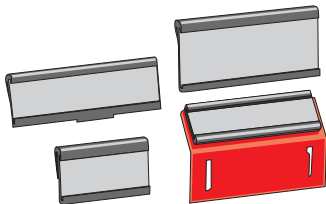

### Clip-on label holders for partition material

Label size mm	Used for	Number	
27 x 12	Trough dividers, dividers, etc.	20 clip-on label holder, 266 labels	<b>134.029.000</b> GBP 7.30
47 x 12	Plastic boxes	20 label holders red	<b>134.034.000</b> GBP 6.80
47 x 12	Dividers, etc.	20 clip-on label holder, 152 labels	<b>134.049.000</b> GBP 7.30
47 x 18	Dividers, etc.	20 clip-on label holder, 104 labels	<b>134.052.000</b> GBP 7.30

## Lista Premium drawer cabinets

Width 1023 mm, depth 572 mm (54 x 27E)

### Configuration examples



## Listra Premium drawer cabinets

Width 1023 mm, depth 572 mm (54 x 27E)

**Configuration instructions: this is how to put your drawer cabinet together.**

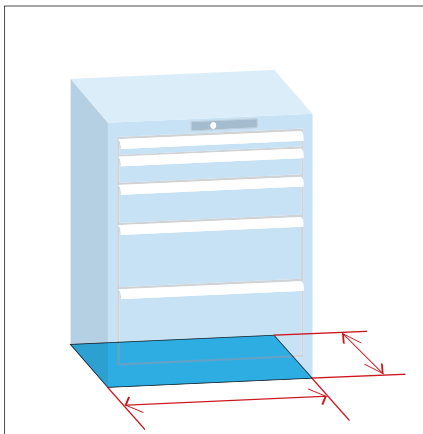

### 1. Selection of the cabinet base area

The first step is the selection of the cabinet base area. It can be indicated in millimetres (width x depth) or Lista units (E x E). The measurements E x E indicate which drawers match which housings.

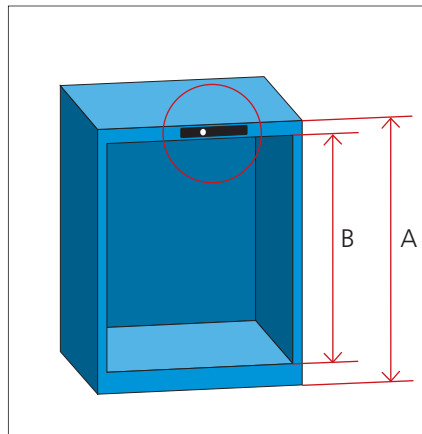

### 2. Selection of housing and locking system

After selecting a base area you can specify the housing. Different heights are available for every floor plan. The selection of housing always includes the choice of the desired locking system and colour.

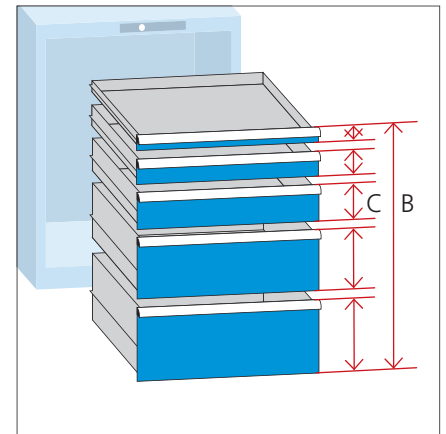

### 3. Selection of drawers

Determine the front height, carrying capacity, and colour of the drawers. The sum total of the front heights C must correspond to the clear height B (refer to figure in point 2). Please also select the type of safety catch.



### 4. Selection of accessories

The drawer cabinet can be combined with cover, base, wheels and push handle for mobile cabinets. Mobile cabinets must be fitted with a drawer safety catch.

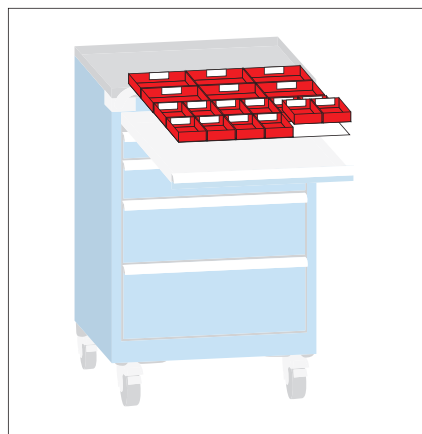

### 5. Selection of partition material

Partition material for drawers is usually ordered as a set. The available selection is large. Please note: The partition material must match the drawer height and useable dimension.

### 6. Determination of the price

The price of the drawer cabinet corresponds to the sum of all selected elements in the corresponding configuration.

# Drawer cabinets Lista Premium

Width 1023 mm, depth 572 mm (54 x 27E)

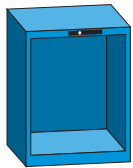

## Housing

Height mm	Clear height mm	Key Lock	Code Lock	Remote Lock	Remote Lock Mobile	Lock without cylinder
700	600	<b>71.102.XXX</b> GBP 239.00	<b>71.161.XXX</b> GBP 279.00	<b>71.220.XXX</b> GBP 394.00	<b>71.265.XXX</b> GBP 464.00	<b>71.043.XXX</b> GBP 230.00
850	750	<b>71.103.XXX</b> GBP 261.00	<b>71.162.XXX</b> GBP 301.00	<b>71.221.XXX</b> GBP 416.00	<b>71.266.XXX</b> GBP 486.00	<b>71.044.XXX</b> GBP 252.00
1000	900	<b>71.104.XXX</b> GBP 272.00	<b>71.163.XXX</b> GBP 312.00	<b>71.222.XXX</b> GBP 427.00	<b>71.267.XXX</b> GBP 497.00	<b>71.045.XXX</b> GBP 263.00
1450	1350	<b>71.105.XXX</b> GBP 326.00	<b>71.164.XXX</b> GBP 366.00	<b>71.223.XXX</b> GBP 481.00		<b>71.046.XXX</b> GBP 317.00

## Accessories Remote Lock

Designation	
Hand-held radio transmitter	<b>74.092.000</b> GBP 23.00
Programming key	<b>74.093.000</b> GBP 33.00
Adapter	<b>74.094.000</b> GBP 33.00
Extension unit 2-pole, 1850 mm	<b>74.098.000</b> GBP 23.00
Extension unit 4-pole, 1850 mm	<b>74.099.000</b> GBP 25.00

## Accessories drawer cabinet without cylinder

Designation	
Cylinder 2C 1 simultaneously lockable	<b>222.377.000</b> GBP 11.00
Cylinder 2C 2 simultaneously lockable	<b>222.378.000</b> GBP 11.00
Cylinder 2C 3 simultaneously lockable	<b>222.379.000</b> GBP 11.00
Cylinder 2C 4 simultaneously lockable	<b>222.380.000</b> GBP 11.00
Cylinder 2C 5 simultaneously lockable	<b>222.381.000</b> GBP 11.00
Cylinder 2C 6 simultaneously lockable	<b>222.382.000</b> GBP 11.00
Cylinder 2C _ simultaneously lockable	<b>222.383.000</b> GBP 12.00
Cylinder main locking system	<b>222.384.000</b> GBP 16.00

## The Lista housing locks

### Key Lock

Standard closure with central locking system and Lista cylinder lock, individual lock, with 2 keys.

### Code Lock

Electronic locking system, a number combination replaces the key. Programmable user codes allow a flexible locking system to be created. Battery powered.

### Remote Lock

Electronic locking system with hand-held radio transmitter (unlocking through radio pulse). A programming key grants access and authorisation. Interlinking of cabinets possible using interlink elements. Connects to main supply (adapter necessary). Please note: hand-held radio transmitter, programming key and adapter not included. Can be ordered optionally if required.

### Remote Lock Mobile

Same functionality as Remote Lock, but with rechargeable battery (requirement for mobile model). Hand-held radio transmitter and programming key not included. Can be ordered optionally if required.

### Lock without cylinder

Lock to be included in complete locking systems (simultaneously or main locking systems). For cylinders ordered with predefined lock numbers (2C 1 – 2C 6) or a freely defined number (2C \_). Should a cylinder not be ordered, the housing will be supplied with a lock cover.

For further information on locking systems see page 17.

## The Lista standard colours (without extra charge)

Please complete the last 3 digits of your product code (.XXX) with the desired colour code.

<b>.010</b>	<b>.020</b>	<b>.030</b>	<b>.040</b>	<b>.050</b>	<b>.060</b>	<b>.070</b>	<b>.080</b>	<b>.090</b>	<b>.100</b>
Light blue RAL 5012	Light grey RAL 7035	Reseda green RAL 6011	Capri blue RAL 5019	Grey metallic NCS S 6502-B	Black NCS S 9000-N	Ruby red RAL 3003	Pigeon grey NCS S 4502-B	Gentian blue RAL 5010	Signal blue RAL 5005

# Drawers Lista Premium

Useable drawer dimension 918 x 459 mm (54 x 27E)

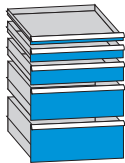

## Drawers 75 kg

Front height mm (useable height)	Standard	Safety catch on the right	Safety catch on the right and left	Double safety catch	Lilo locking device
50 (29)	<b>72.080.XXX</b> GBP 69.00	<b>72.190.XXX</b> GBP 70.00	<b>72.300.XXX</b> GBP 71.00	<b>72.410.XXX</b> GBP 89.00	

## Drawers 200 kg

Front height mm (useable height)	Standard	Safety catch on the right	Safety catch on the right and left	Double safety catch	Lilo locking device
75 (54)	<b>72.081.XXX</b> GBP 101.00	<b>72.191.XXX</b> GBP 102.00	<b>72.301.XXX</b> GBP 103.00	<b>72.411.XXX</b> GBP 121.00	<b>72.475.XXX</b> GBP 126.00
100 (79)	<b>72.082.XXX</b> GBP 106.00	<b>72.192.XXX</b> GBP 107.00	<b>72.302.XXX</b> GBP 108.00	<b>72.412.XXX</b> GBP 126.00	<b>72.476.XXX</b> GBP 131.00
125 (104)	<b>72.083.XXX</b> GBP 109.00	<b>72.193.XXX</b> GBP 110.00	<b>72.303.XXX</b> GBP 111.00	<b>72.413.XXX</b> GBP 129.00	<b>72.477.XXX</b> GBP 134.00
150 (129)	<b>72.084.XXX</b> GBP 110.00	<b>72.194.XXX</b> GBP 111.00	<b>72.304.XXX</b> GBP 112.00	<b>72.414.XXX</b> GBP 130.00	<b>72.478.XXX</b> GBP 135.00
200 (179)	<b>72.085.XXX</b> GBP 121.00	<b>72.195.XXX</b> GBP 122.00	<b>72.305.XXX</b> GBP 123.00	<b>72.415.XXX</b> GBP 141.00	<b>72.479.XXX</b> GBP 146.00
250 (229)	<b>72.086.XXX</b> GBP 130.00	<b>72.196.XXX</b> GBP 131.00	<b>72.306.XXX</b> GBP 132.00	<b>72.416.XXX</b> GBP 150.00	<b>72.480.XXX</b> GBP 155.00
300 (279)	<b>72.087.XXX</b> GBP 141.00	<b>72.197.XXX</b> GBP 142.00	<b>72.307.XXX</b> GBP 143.00	<b>72.417.XXX</b> GBP 161.00	<b>72.481.XXX</b> GBP 166.00

## The Lista drawer safety catch

### Standard

Standard model without drawer-locking facility.

### Safety catch on the right

Mobile cabinets must be fitted with a drawer safety catch. Prevents unintended opening of drawers even when the cabinet is not locked.

### Safety catch on the right and left as well as double safety catch

Increased safety for use on mobile equipment. Safety catch right and left, operated with both hands. Double catch centrally operated with one hand.

### Lilo locking device

The Lilo locking device (Lock-in – Lock-out) blocks the drawer in an open or closed state. A significant security and comfort benefit, especially for heavy loads.

## The Lista standard colours (without extra charge)

Please complete the last 3 digits of your product code (.XXX) with the desired colour code.

<b>.010</b>	<b>.020</b>	<b>.030</b>	<b>.040</b>	<b>.050</b>	<b>.060</b>	<b>.070</b>	<b>.080</b>	<b>.090</b>	<b>.100</b>
Light blue RAL 5012	Light grey RAL 7035	Reseda green RAL 6011	Capri blue RAL 5019	Grey metallic NCS S 6502-B	Black NCS S 9000-N	Ruby red RAL 3003	Pigeon grey NCS S 4502-B	Gentian blue RAL 5010	Signal blue RAL 5005

## Housing accessories Lista Premium

Width 1023 mm, depth 572 mm (54 x 27E)



### Cover

Available with or without raised edging. Colour: black.

#### Designation

Ribbed mat, single, black	<b>74.019.000</b> GBP 25.00
Retainer top with raised edges, 3-sided, incl. ribbed mat (black)	<b>74.030.000</b> GBP 63.00



### Base

To adjust the height. Colour: black.

Liftable base: This allows the cabinet to be moved with a forklift truck. Colour: black.

#### Designation

Housing base, black, height 50 mm	<b>74.057.000</b> GBP 47.00
Liftable housing base, black, height 100 mm	<b>74.064.000</b> GBP 55.00
Base cover, black, for liftable base	<b>74.068.000</b> GBP 18.00



### Mobile model

Raised edging, 4-sided, incl. ribbed mat, black, 2 steering castors with stops, 2 support castors, max. load capacity 400 kg, with either nylon or rubber wheels, 1 pushing handle.

#### Designation

Retainer top with raised edges, 4-sided, incl. ribbed mat (black) and push handle	<b>74.041.000</b> GBP 93.00
Pair of castor supports, with nylon roller set ø 100 mm	<b>74.077.000</b> GBP 62.00
Pair of castor supports, with rubber roller set ø 100 mm	<b>74.078.000</b> GBP 82.00
Pair of castor supports, with rubber roller set ø 160 mm	<b>74.079.000</b> GBP 128.00

# Partition material Lista Premium

Useable drawer dimension 918 x 459 mm (54 x 27E)

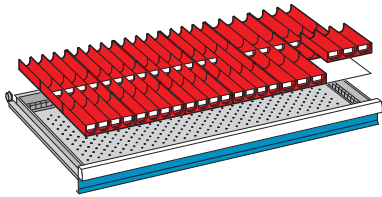

## Troughs

For front height mm	
75	<b>80.001.000</b> GBP 42.00
12 trough-shaped parts: 4 grooves 30 trough dividers: 4 grooves 6 trough-shaped parts: 3 grooves 10 trough dividers: 3 grooves	

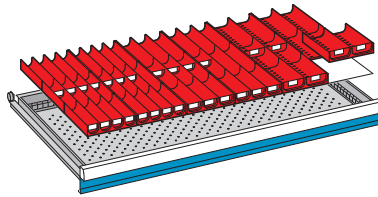

## Troughs

For front height mm	
75, 100, 125	<b>80.002.000</b> GBP 40.50
6 trough-shaped parts: 4 grooves 20 trough dividers: 4 grooves 6 trough-shaped parts: 3 grooves 10 trough dividers: 3 grooves 6 trough-shaped parts: 2 grooves 10 trough dividers: 2 grooves	

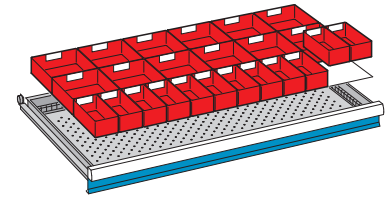

## Plastic boxes

For front height mm	
50	<b>80.045.000</b> GBP 29.00
75	<b>80.046.000</b> GBP 36.50
100, 125	<b>80.047.000</b> GBP 53.50
12 plastic boxes: 150 x 75 mm 12 plastic boxes: 150 x 150 mm	

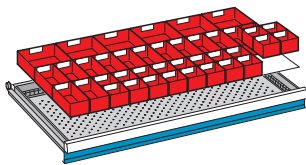

## Plastic boxes

For front height mm	
50	<b>80.043.000</b> GBP 36.00
75	<b>80.044.000</b> GBP 45.50
20 plastic boxes: 75 x 75 mm 14 plastic boxes: 150 x 75 mm 6 plastic boxes: 150 x 150 mm	

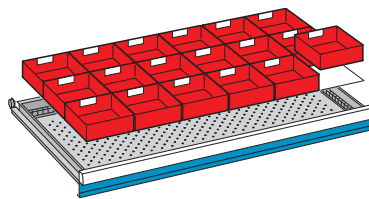

## Plastic boxes

For front height mm	
50	<b>80.419.000</b> GBP 27.50
75	<b>80.049.000</b> GBP 33.00
100, 125	<b>80.050.000</b> GBP 43.00
18 plastic boxes: 150 x 150 mm	

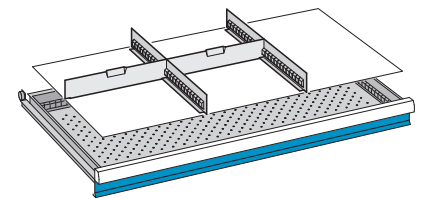

## Dividers

For front height mm	
50	<b>80.425.000</b> GBP 7.30
75	<b>80.426.000</b> GBP 7.80
100, 125	<b>80.427.000</b> GBP 10.00
150	<b>80.428.000</b> GBP 12.80
200	<b>80.429.000</b> GBP 16.30
250	<b>80.430.000</b> GBP 18.80
300	<b>80.431.000</b> GBP 21.30
2 slotted partitions: 27E 2 dividers: 18E	

# Partition material Lista Premium

Useable drawer dimension 918 x 459 mm (54 x 27E)

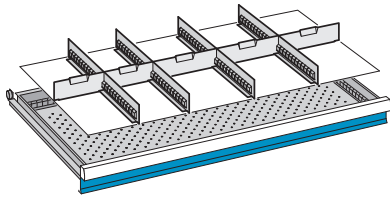

## Dividers

For front height mm	
50	<b>80.015.000</b> GBP 14.00
75	<b>80.016.000</b> GBP 15.50
100, 125	<b>80.017.000</b> GBP 20.30
150	<b>80.018.000</b> GBP 24.50
200	<b>80.019.000</b> GBP 31.00
250	<b>80.020.000</b> GBP 36.50
300	<b>80.696.000</b> GBP 41.50

4 slotted partitions: 27E  
2 dividers: 9E  
3 dividers: 12E

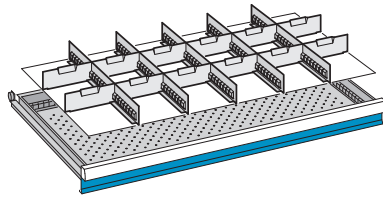

## Dividers

For front height mm	
50	<b>80.009.000</b> GBP 20.50
75	<b>80.010.000</b> GBP 22.80
100, 125	<b>80.011.000</b> GBP 30.00
150	<b>80.012.000</b> GBP 35.50
200	<b>80.013.000</b> GBP 44.00
250	<b>80.014.000</b> GBP 51.50
300	<b>80.697.000</b> GBP 60.50

5 slotted partitions: 27E  
12 dividers: 9E

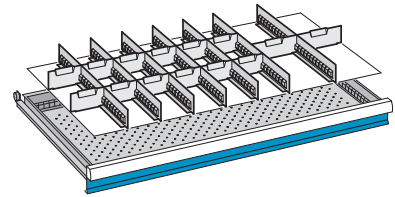

## Dividers

For front height mm	
50	<b>80.003.000</b> GBP 25.00
75	<b>80.004.000</b> GBP 28.00
100, 125	<b>80.005.000</b> GBP 37.50

7 slotted partitions: 27E  
12 dividers: 6E  
2 dividers: 9E

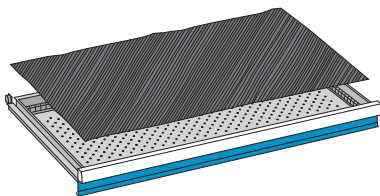

## Anti-slide mat

Designation	
Anti-slide mat anthracite	<b>119.119.000</b> GBP 6.00

Coating: special soft PVC foam.  
Extremely hardwearing and tear-proof.

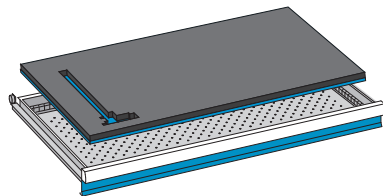

## PE plastic foam inserts

Designation	
Plastic foam insert, black. Thickness 25 mm	<b>80.923.000</b> GBP 22.50
Underlay blue. Thickness 5 mm	<b>80.924.000</b> GBP 14.00

Pre-cut inserts for the most popular tool sets on page 149.

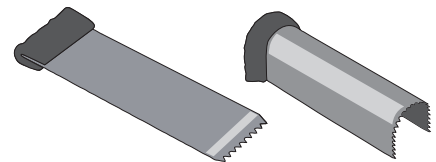

## Plunge cutters

Designation	
Plunge cutter 20 mm	<b>80.920.000</b> GBP 2.60
Plunge cutter 50 mm	<b>80.921.000</b> GBP 4.80
Plunge cutter "U" 20 x 20 mm	<b>80.922.000</b> GBP 9.00

Plunge cutter for PE plastic foam inserts.

## Partition material Lista Premium

Useable drawer dimension 918 x 459 mm (54 x 27E)

### Lista Script labels for partition material

Label size mm	Used for	Number	
47 x 18	Plastic boxes, clip-on label holders	2 sheets (A4), 52 labels each	<b>18.785.000</b> GBP 1.60
47 x 12	Plastic boxes, clip-on label holders	2 sheets (A4), 76 labels each	<b>18.786.000</b> GBP 1.60
27 x 12	Plastic boxes, clip-on label holders	2 sheets (A4), 133 labels each	<b>18.787.000</b> GBP 1.60

### Lista Script labels for cabinet labelling

Label size mm	Used for	Number	
210 x 22 / 70 x 22	Drawer handle, drawer cabinet	5 sheets (A4), 10/30 labels each	<b>18.784.000</b> GBP 2.60

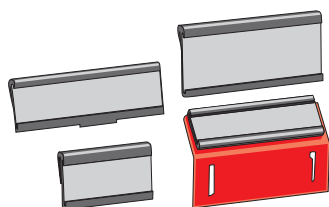

### Clip-on label holders for partition material

Label size mm	Used for	Number	
27 x 12	Trough dividers, dividers, etc.	20 clip-on label holder, 266 labels	<b>134.029.000</b> GBP 7.30
47 x 12	Plastic boxes	20 label holders red	<b>134.034.000</b> GBP 6.80
47 x 12	Dividers, etc.	20 clip-on label holder, 152 labels	<b>134.049.000</b> GBP 7.30
47 x 18	Dividers, etc.	20 clip-on label holder, 104 labels	<b>134.052.000</b> GBP 7.30

## Lista Premium drawer cabinets

Width 1023 mm, depth 725 mm (54 x 36E)

### Configuration examples



## Lista Premium drawer cabinets

Width 1023 mm, depth 725 mm (54 x 36E)

**Configuration instructions: this is how to put your drawer cabinet together.**

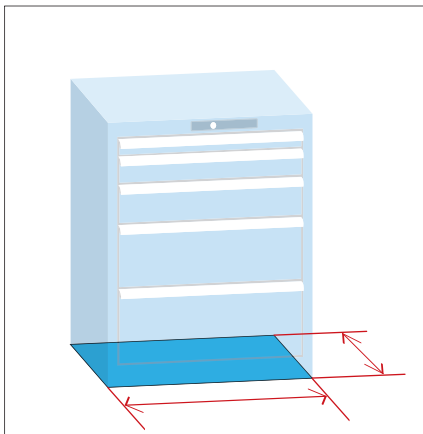

### 1. Selection of the cabinet base area

The first step is the selection of the cabinet base area. It can be indicated in millimetres (width x depth) or Lista units (E x E). The measurements E x E indicate which drawers match which housings.

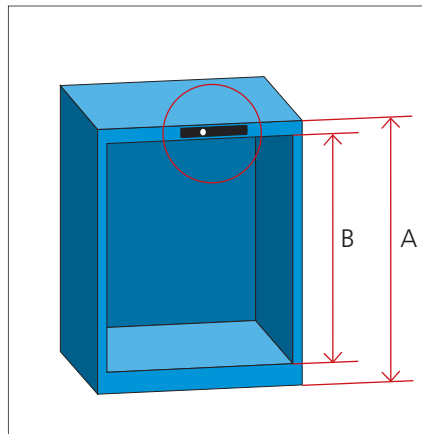

### 2. Selection of housing and locking system

After selecting a base area you can specify the housing. Different heights are available for every floor plan. The selection of housing always includes the choice of the desired locking system and colour.

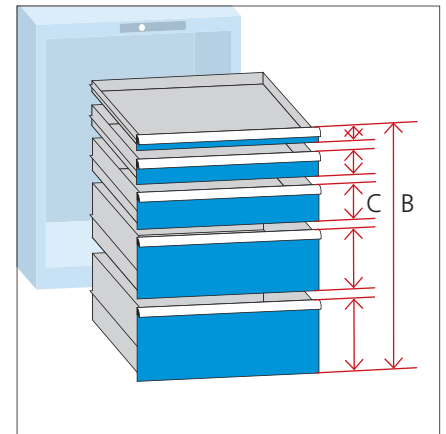

### 3. Selection of drawers

Determine the front height, carrying capacity, and colour of the drawers. The sum total of the front heights C must correspond to the clear height B (refer to figure in point 2). Please also select the type of safety catch.



### 4. Selection of accessories

The drawer cabinet can be combined with cover, base, wheels and push handle for mobile cabinets. Mobile cabinets must be fitted with a drawer safety catch.

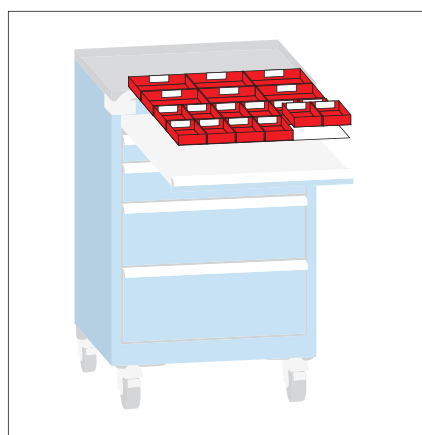

### 5. Selection of partition material

Partition material for drawers is usually ordered as a set. The available selection is large. Please note: The partition material must match the drawer height and useable dimension.

### 6. Determination of the price

The price of the drawer cabinet corresponds to the sum of all selected elements in the corresponding configuration.

## Drawer cabinets Lista Premium

Width 1023 mm, depth 725 mm (54 x 36E)

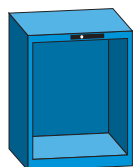

### Housing

Height mm	Clear height mm	Key Lock	Code Lock	Remote Lock	Remote Lock Mobile	Lock without cylinder
700	600	<b>71.106.XXX</b> GBP 274.00	<b>71.165.XXX</b> GBP 314.00	<b>71.224.XXX</b> GBP 429.00	<b>71.268.XXX</b> GBP 499.00	<b>71.047.XXX</b> GBP 265.00
850	750	<b>71.107.XXX</b> GBP 289.00	<b>71.166.XXX</b> GBP 329.00	<b>71.225.XXX</b> GBP 444.00	<b>71.269.XXX</b> GBP 514.00	<b>71.048.XXX</b> GBP 280.00
1000	900	<b>71.108.XXX</b> GBP 299.00	<b>71.167.XXX</b> GBP 339.00	<b>71.226.XXX</b> GBP 454.00	<b>71.270.XXX</b> GBP 524.00	<b>71.049.XXX</b> GBP 290.00
1450	1350	<b>71.109.XXX</b> GBP 349.00	<b>71.168.XXX</b> GBP 389.00	<b>71.227.XXX</b> GBP 504.00		<b>71.050.XXX</b> GBP 340.00

### Accessories Remote Lock

Designation	
Hand-held radio transmitter	<b>74.092.000</b> GBP 23.00
Programming key	<b>74.093.000</b> GBP 33.00
Adapter	<b>74.094.000</b> GBP 33.00
Extension unit 2-pole, 1850 mm	<b>74.098.000</b> GBP 23.00
Extension unit 4-pole, 1850 mm	<b>74.099.000</b> GBP 25.00

### Accessories drawer cabinet without cylinder

Designation	
Cylinder 2C 1 simultaneously lockable	<b>222.377.000</b> GBP 11.00
Cylinder 2C 2 simultaneously lockable	<b>222.378.000</b> GBP 11.00
Cylinder 2C 3 simultaneously lockable	<b>222.379.000</b> GBP 11.00
Cylinder 2C 4 simultaneously lockable	<b>222.380.000</b> GBP 11.00
Cylinder 2C 5 simultaneously lockable	<b>222.381.000</b> GBP 11.00
Cylinder 2C 6 simultaneously lockable	<b>222.382.000</b> GBP 11.00
Cylinder 2C _ simultaneously lockable	<b>222.383.000</b> GBP 12.00
Cylinder main locking system	<b>222.384.000</b> GBP 16.00

### The Lista housing locks

#### Key Lock

Standard closure with central locking system and Lista cylinder lock, individual lock, with 2 keys.

#### Code Lock

Electronic locking system, a number combination replaces the key. Programmable user codes allow a flexible locking system to be created. Battery powered.

#### Remote Lock

Electronic locking system with hand-held radio transmitter (unlocking through radio pulse). A programming key grants access and authorisation. Interlinking of cabinets possible using interlink elements. Connects to main supply (adapter necessary). Please note: hand-held radio transmitter, programming key and adapter not included. Can be ordered optionally if required.

#### Remote Lock Mobile

Same functionality as Remote Lock, but with rechargeable battery (requirement for mobile model). Hand-held radio transmitter and programming key not included. Can be ordered optionally if required.

#### Lock without cylinder

Lock to be included in complete locking systems (simultaneously or main locking systems). For cylinders ordered with predefined lock numbers (2C 1 – 2C 6) or a freely defined number (2C \_). Should a cylinder not be ordered, the housing will be supplied with a lock cover.

For further information on locking systems see page 17.

### The Lista standard colours (without extra charge)

Please complete the last 3 digits of your product code (.XXX) with the desired colour code.

<b>.010</b>	<b>.020</b>	<b>.030</b>	<b>.040</b>	<b>.050</b>	<b>.060</b>	<b>.070</b>	<b>.080</b>	<b>.090</b>	<b>.100</b>
Light blue RAL 5012	Light grey RAL 7035	Reseda green RAL 6011	Capri blue RAL 5019	Grey metallic NCS S 6502-B	Black NCS S 9000-N	Ruby red RAL 3003	Pigeon grey NCS S 4502-B	Gentian blue RAL 5010	Signal blue RAL 5005

# Drawers Lista Premium

Useable drawer dimension 918 x 612 mm (54 x 36E)

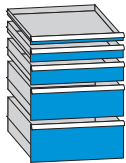

## Drawers 75 kg

Front height mm (useable height)	Standard	Safety catch on the right	Safety catch on the right and left	Double safety catch	Lilo locking device
50 (29)	<b>72.088.XXX</b> GBP 77.00	<b>72.198.XXX</b> GBP 78.00	<b>72.308.XXX</b> GBP 79.00	<b>72.418.XXX</b> GBP 97.00	

## Drawers 200 kg

Front height mm (useable height)	Standard	Safety catch on the right	Safety catch on the right and left	Double safety catch	Lilo locking device
75 (54)	<b>72.089.XXX</b> GBP 114.00	<b>72.199.XXX</b> GBP 115.00	<b>72.309.XXX</b> GBP 116.00	<b>72.419.XXX</b> GBP 134.00	<b>72.482.XXX</b> GBP 139.00
100 (79)	<b>72.090.XXX</b> GBP 120.00	<b>72.200.XXX</b> GBP 121.00	<b>72.310.XXX</b> GBP 122.00	<b>72.420.XXX</b> GBP 140.00	<b>72.483.XXX</b> GBP 145.00
125 (104)	<b>72.091.XXX</b> GBP 121.00	<b>72.201.XXX</b> GBP 122.00	<b>72.311.XXX</b> GBP 123.00	<b>72.421.XXX</b> GBP 141.00	<b>72.484.XXX</b> GBP 146.00
150 (129)	<b>72.092.XXX</b> GBP 122.00	<b>72.202.XXX</b> GBP 123.00	<b>72.312.XXX</b> GBP 124.00	<b>72.422.XXX</b> GBP 142.00	<b>72.485.XXX</b> GBP 147.00
200 (179)	<b>72.093.XXX</b> GBP 127.00	<b>72.203.XXX</b> GBP 128.00	<b>72.313.XXX</b> GBP 129.00	<b>72.423.XXX</b> GBP 147.00	<b>72.486.XXX</b> GBP 152.00
250 (229)	<b>72.094.XXX</b> GBP 133.00	<b>72.204.XXX</b> GBP 134.00	<b>72.314.XXX</b> GBP 135.00	<b>72.424.XXX</b> GBP 153.00	<b>72.487.XXX</b> GBP 158.00
300 (279)	<b>72.095.XXX</b> GBP 153.00	<b>72.205.XXX</b> GBP 154.00	<b>72.315.XXX</b> GBP 155.00	<b>72.425.XXX</b> GBP 173.00	<b>72.488.XXX</b> GBP 178.00

## The Lista drawer safety catch

### Standard

Standard model without drawer-locking facility.

### Safety catch on the right

Mobile cabinets must be fitted with a drawer safety catch. Prevents unintended opening of drawers even when the cabinet is not locked.

### Safety catch on the right and left as well as double safety catch

Increased safety for use on mobile equipment. Safety catch right and left, operated with both hands. Double catch centrally operated with one hand.

### Lilo locking device

The Lilo locking device (Lock-in – Lock-out) blocks the drawer in an open or closed state. A significant security and comfort benefit, especially for heavy loads.

## The Lista standard colours (without extra charge)

Please complete the last 3 digits of your product code (.XXX) with the desired colour code.

<b>.010</b>	<b>.020</b>	<b>.030</b>	<b>.040</b>	<b>.050</b>	<b>.060</b>	<b>.070</b>	<b>.080</b>	<b>.090</b>	<b>.100</b>
Light blue RAL 5012	Light grey RAL 7035	Reseda green RAL 6011	Capri blue RAL 5019	Grey metallic NCS S 6502-B	Black NCS S 9000-N	Ruby red RAL 3003	Pigeon grey NCS S 4502-B	Gentian blue RAL 5010	Signal blue RAL 5005

## Housing accessories Lista Premium

Width 1023 mm, depth 725 mm (54 x 36E)



### Cover

Available with or without raised edging. Colour: black.

#### Designation

Ribbed mat, single, black	<b>74.020.000</b> GBP 32.00
Retainer top with raised edges, 3-sided, incl. ribbed mat (black)	<b>74.031.000</b> GBP 78.00



### Base

To adjust the height. Colour: black.

Liftable base: This allows the cabinet to be moved with a forklift truck. Colour: black.

#### Designation

Housing base, black, height 50 mm	<b>74.058.000</b> GBP 49.00
Liftable housing base, black, height 100 mm	<b>74.065.000</b> GBP 60.00
Base cover, black, for liftable base	<b>74.068.000</b> GBP 18.00

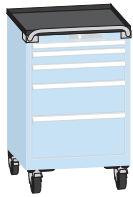

### Mobile model

Raised edging, 4-sided, incl. ribbed mat, black, 2 steering castors with stops, 2 support castors, max. load capacity 400 kg, with either nylon or rubber wheels, 1 pushing handle.

#### Designation

Retainer top with raised edges, 4-sided, incl. ribbed mat (black) and push handle	<b>74.042.000</b> GBP 105.00
Pair of castor supports, with nylon roller set ø 100 mm	<b>74.080.000</b> GBP 64.00
Pair of castor supports, with rubber roller set ø 100 mm	<b>74.081.000</b> GBP 85.00
Pair of castor supports, with rubber roller set ø 160 mm	<b>74.082.000</b> GBP 131.00

# Partition material Lista Premium

Useable drawer dimension 918 x 612 mm (54 x 36E)

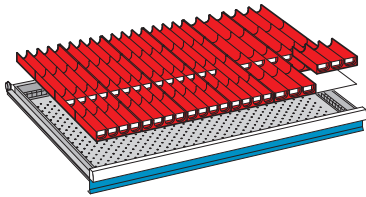

## Troughs

For front height mm	
50	<b>80.387.000</b> GBP 53.00
16 trough-shaped parts: 4 grooves 30 trough dividers: 4 grooves 8 trough-shaped parts: 3 grooves 10 trough dividers: 3 grooves	

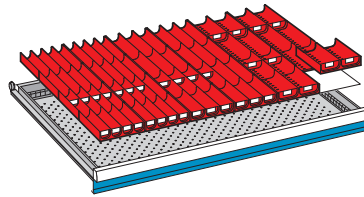

## Troughs

For front height mm	
50	<b>80.388.000</b> GBP 51.00
8 trough-shaped parts: 4 grooves 20 trough dividers: 4 grooves 8 trough-shaped parts: 3 grooves 10 trough dividers: 3 grooves 8 trough-shaped parts: 2 grooves 10 trough dividers: 2 grooves	

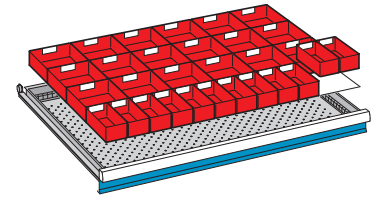

## Plastic boxes

For front height mm	
50	<b>80.449.000</b> GBP 38.00
75	<b>80.405.000</b> GBP 47.00
100, 125	<b>80.406.000</b> GBP 68.00
12 plastic boxes: 150 x 75 mm 18 plastic boxes: 150 x 150 mm	

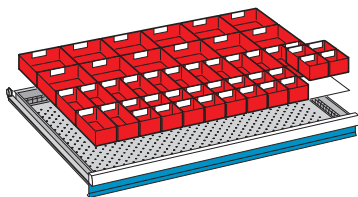

## Plastic boxes

For front height mm	
50	<b>80.450.000</b> GBP 45.00
75	<b>80.407.000</b> GBP 56.00
20 plastic boxes: 75 x 75 mm 14 plastic boxes: 150 x 75 mm 12 plastic boxes: 150 x 150 mm	

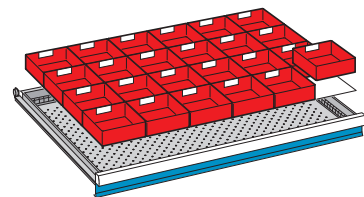

## Plastic boxes

For front height mm	
50	<b>80.451.000</b> GBP 36.50
75	<b>80.452.000</b> GBP 43.50
100, 125	<b>80.453.000</b> GBP 57.50
24 plastic boxes: 150 x 150 mm	

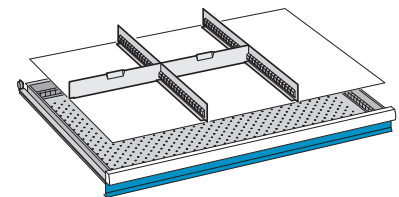

## Dividers

For front height mm	
50	<b>80.457.000</b> GBP 7.30
75	<b>80.458.000</b> GBP 8.00
100, 125	<b>80.459.000</b> GBP 10.30
150	<b>80.460.000</b> GBP 13.30
200	<b>80.461.000</b> GBP 16.00
250	<b>80.462.000</b> GBP 19.50
300	<b>80.463.000</b> GBP 22.00
2 slotted partitions: 36E 2 dividers: 18E	

# Partition material Lista Premium

Useable drawer dimension 918 x 612 mm (54 x 36E)

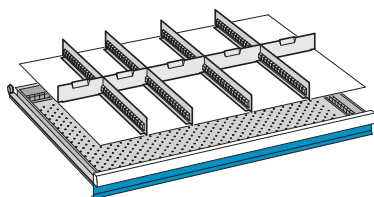

## Dividers

For front height mm	
50	<b>80.533.000</b> GBP 14.30
75	<b>80.389.000</b> GBP 16.00
100, 125	<b>80.390.000</b> GBP 20.80
150	<b>80.391.000</b> GBP 25.50
200	<b>80.392.000</b> GBP 31.00
250	<b>80.393.000</b> GBP 37.50
300	<b>80.394.000</b> GBP 43.00

4 slotted partitions: 36E  
2 dividers: 9E  
3 dividers: 12E

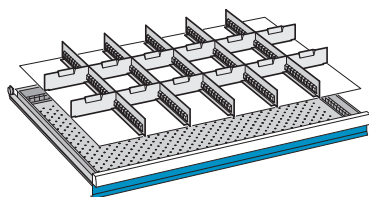

## Dividers

For front height mm	
50	<b>80.479.000</b> GBP 21.00
75	<b>80.395.000</b> GBP 23.50
100, 125	<b>80.396.000</b> GBP 31.00
150	<b>80.397.000</b> GBP 36.50
200	<b>80.398.000</b> GBP 43.50
250	<b>80.399.000</b> GBP 53.00
300	<b>80.400.000</b> GBP 62.00

5 slotted partitions: 36E  
12 dividers: 9E

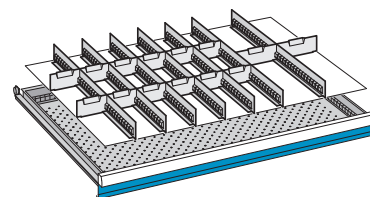

## Dividers

For front height mm	
50	<b>80.481.000</b> GBP 26.00
75	<b>80.403.000</b> GBP 29.00
100, 125	<b>80.404.000</b> GBP 38.50

7 slotted partitions: 36E  
12 dividers: 6E  
2 dividers: 9E

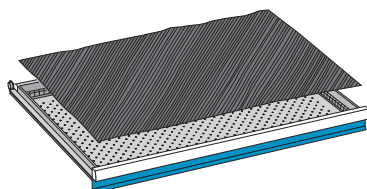

## Anti-slide mat

Designation	
Anti-slide mat anthracite	<b>130.745.000</b> GBP 8.00

Coating: special soft PVC foam.  
Extremely hardwearing and tear-proof.

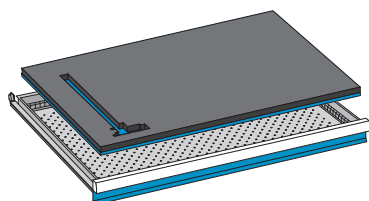

## PE plastic foam inserts

Designation	
Plastic foam insert, black. Thickness 25 mm	<b>80.919.000</b> GBP 25.50
Underlay blue. Thickness 5 mm	<b>80.908.000</b> GBP 15.30

Pre-cut inserts for the most popular tool sets on page 149.

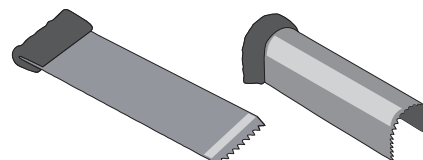

## Plunge cutters

Designation	
Plunge cutter 20 mm	<b>80.920.000</b> GBP 2.60
Plunge cutter 50 mm	<b>80.921.000</b> GBP 4.80
Plunge cutter "U" 20 x 20 mm	<b>80.922.000</b> GBP 9.00

Plunge cutter for PE plastic foam inserts.

## Partition material Lista Premium

Useable drawer dimension 918 x 612 mm (54 x 36E)

### Lista Script labels for partition material

Label size mm	Used for	Number	
47 x 18	Plastic boxes, clip-on label holders	2 sheets (A4), 52 labels each	<b>18.785.000</b> GBP 1.60
47 x 12	Plastic boxes, clip-on label holders	2 sheets (A4), 76 labels each	<b>18.786.000</b> GBP 1.60
27 x 12	Plastic boxes, clip-on label holders	2 sheets (A4), 133 labels each	<b>18.787.000</b> GBP 1.60

### Lista Script labels for cabinet labelling

Label size mm	Used for	Number	
210 x 22 / 70 x 22	Drawer handle, drawer cabinet	5 sheets (A4), 10/30 labels each	<b>18.784.000</b> GBP 2.60

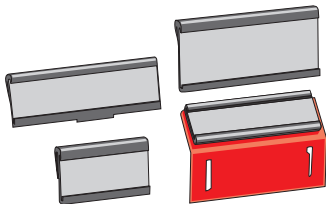

### Clip-on label holders for partition material

Label size mm	Used for	Number	
27 x 12	Trough dividers, dividers, etc.	20 clip-on label holder, 266 labels	<b>134.029.000</b> GBP 7.30
47 x 12	Plastic boxes	20 label holders red	<b>134.034.000</b> GBP 6.80
47 x 12	Dividers, etc.	20 clip-on label holder, 152 labels	<b>134.049.000</b> GBP 7.30
47 x 18	Dividers, etc.	20 clip-on label holder, 104 labels	<b>134.052.000</b> GBP 7.30

## Lista Premium drawer cabinets

Width 1193 mm, depth 725 mm (64 x 36E)

### Configuration examples



## Lista Premium drawer cabinets

Width 1193 mm, depth 725 mm (64 x 36E)

**Configuration instructions: this is how to put your drawer cabinet together.**

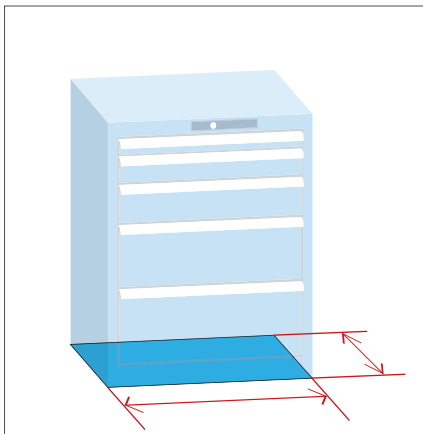

### 1. Selection of the cabinet base area

The first step is the selection of the cabinet base area. It can be indicated in millimetres (width x depth) or Lista units (E x E). The measurements E x E indicate which drawers match which housings.

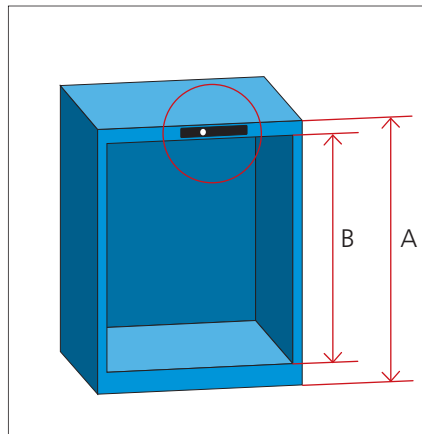

### 2. Selection of housing and locking system

After selecting a base area you can specify the housing. Different heights are available for every floor plan. The selection of housing always includes the choice of the desired locking system and colour.

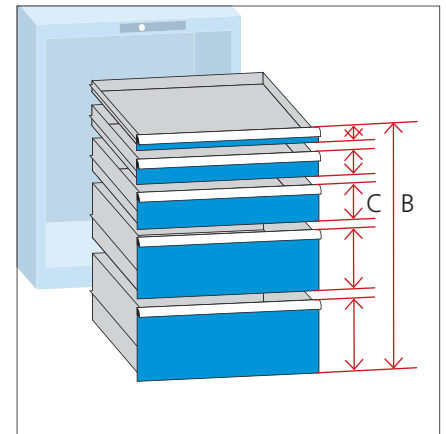

### 3. Selection of drawers

Determine the front height, carrying capacity, and colour of the drawers. The sum total of the front heights C must correspond to the clear height B (refer to figure in point 2). Please also select the type of safety catch.



### 4. Selection of accessories

The drawer cabinet can be combined with cover, base, wheels and push handle for mobile cabinets. Mobile cabinets must be fitted with a drawer safety catch.

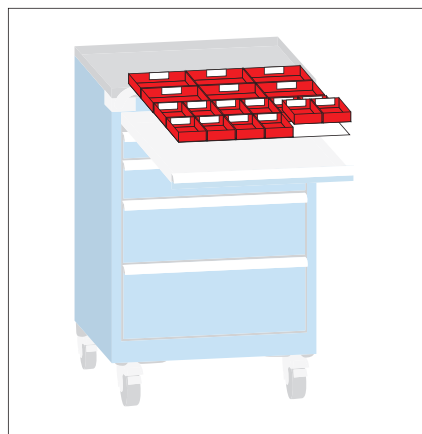

### 5. Selection of partition material

Partition material for drawers is usually ordered as a set. The available selection is large. Please note: The partition material must match the drawer height and useable dimension.

### 6. Determination of the price

The price of the drawer cabinet corresponds to the sum of all selected elements in the corresponding configuration.

## Drawer cabinets Lista Premium

Width 1193 mm, depth 725 mm (64 x 36E)

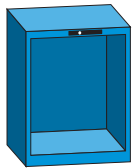

### Housing

Height mm	Clear height mm	Key Lock	Code Lock	Remote Lock	Remote Lock Mobile	Lock without cylinder
700	600	<b>71.110.XXX</b> GBP 294.00	<b>71.169.XXX</b> GBP 334.00	<b>71.228.XXX</b> GBP 449.00	<b>71.271.XXX</b> GBP 519.00	<b>71.051.XXX</b> GBP 285.00
1000	900	<b>71.111.XXX</b> GBP 329.00	<b>71.170.XXX</b> GBP 369.00	<b>71.229.XXX</b> GBP 484.00	<b>71.272.XXX</b> GBP 554.00	<b>71.052.XXX</b> GBP 320.00
1325	1225	<b>71.112.XXX</b> GBP 376.00	<b>71.171.XXX</b> GBP 416.00	<b>71.230.XXX</b> GBP 531.00		<b>71.053.XXX</b> GBP 367.00
1450	1350	<b>71.113.XXX</b> GBP 406.00	<b>71.172.XXX</b> GBP 446.00	<b>71.231.XXX</b> GBP 561.00		<b>71.054.XXX</b> GBP 397.00

### Accessories Remote Lock

Designation	
Hand-held radio transmitter	<b>74.092.000</b> GBP 23.00
Programming key	<b>74.093.000</b> GBP 33.00
Adapter	<b>74.094.000</b> GBP 33.00
Extension unit 2-pole, 1850 mm	<b>74.098.000</b> GBP 23.00
Extension unit 4-pole, 1850 mm	<b>74.099.000</b> GBP 25.00

### Accessories drawer cabinet without cylinder

Designation	
Cylinder 2C 1 simultaneously lockable	<b>222.377.000</b> GBP 11.00
Cylinder 2C 2 simultaneously lockable	<b>222.378.000</b> GBP 11.00
Cylinder 2C 3 simultaneously lockable	<b>222.379.000</b> GBP 11.00
Cylinder 2C 4 simultaneously lockable	<b>222.380.000</b> GBP 11.00
Cylinder 2C 5 simultaneously lockable	<b>222.381.000</b> GBP 11.00
Cylinder 2C 6 simultaneously lockable	<b>222.382.000</b> GBP 11.00
Cylinder 2C _ simultaneously lockable	<b>222.383.000</b> GBP 12.00
Cylinder main locking system	<b>222.384.000</b> GBP 16.00

### The Lista housing locks

#### Key Lock

Standard closure with central locking system and Lista cylinder lock, individual lock, with 2 keys.

#### Code Lock

Electronic locking system, a number combination replaces the key. Programmable user codes allow a flexible locking system to be created. Battery powered.

#### Remote Lock

Electronic locking system with hand-held radio transmitter (unlocking through radio pulse). A programming key grants access and authorisation. Interlinking of cabinets possible using interlink elements. Connects to main supply (adapter necessary). Please note: hand-held radio transmitter, programming key and adapter not included. Can be ordered optionally if required.

#### Remote Lock Mobile

Same functionality as Remote Lock, but with rechargeable battery (requirement for mobile model). Hand-held radio transmitter and programming key not included. Can be ordered optionally if required.

#### Lock without cylinder

Lock to be included in complete locking systems (simultaneously or main locking systems). For cylinders ordered with predefined lock numbers (2C 1 – 2C 6) or a freely defined number (2C \_). Should a cylinder not be ordered, the housing will be supplied with a lock cover.

For further information on locking systems see page 17.

### The Lista standard colours (without extra charge)

Please complete the last 3 digits of your product code (.XXX) with the desired colour code.

<b>.010</b>	<b>.020</b>	<b>.030</b>	<b>.040</b>	<b>.050</b>	<b>.060</b>	<b>.070</b>	<b>.080</b>	<b>.090</b>	<b>.100</b>
Light blue RAL 5012	Light grey RAL 7035	Reseda green RAL 6011	Capri blue RAL 5019	Grey metallic NCS S 6502-B	Black NCS S 9000-N	Ruby red RAL 3003	Pigeon grey NCS S 4502-B	Gentian blue RAL 5010	Signal blue RAL 5005

# Drawers Lista Premium

Useable drawer dimension 1088 x 612 mm (64 x 36E)

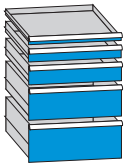

## Drawers 200 kg

Front height mm (useable height)	Standard	Safety catch on the right	Safety catch on the right and left	Double safety catch	Lilo locking device
75 (54)	<b>72.096.XXX</b> GBP 130.00	<b>72.206.XXX</b> GBP 131.00	<b>72.316.XXX</b> GBP 132.00	<b>72.426.XXX</b> GBP 150.00	<b>72.489.XXX</b> GBP 155.00
100 (79)	<b>72.097.XXX</b> GBP 134.00	<b>72.207.XXX</b> GBP 135.00	<b>72.317.XXX</b> GBP 136.00	<b>72.427.XXX</b> GBP 154.00	<b>72.490.XXX</b> GBP 159.00
125 (104)	<b>72.098.XXX</b> GBP 138.00	<b>72.208.XXX</b> GBP 139.00	<b>72.318.XXX</b> GBP 140.00	<b>72.428.XXX</b> GBP 158.00	<b>72.491.XXX</b> GBP 163.00
150 (129)	<b>72.099.XXX</b> GBP 143.00	<b>72.209.XXX</b> GBP 144.00	<b>72.319.XXX</b> GBP 145.00	<b>72.429.XXX</b> GBP 163.00	<b>72.492.XXX</b> GBP 168.00
200 (179)	<b>72.100.XXX</b> GBP 149.00	<b>72.210.XXX</b> GBP 150.00	<b>72.320.XXX</b> GBP 151.00	<b>72.430.XXX</b> GBP 169.00	<b>72.493.XXX</b> GBP 174.00
250 (229)	<b>72.101.XXX</b> GBP 152.00	<b>72.211.XXX</b> GBP 153.00	<b>72.321.XXX</b> GBP 154.00	<b>72.431.XXX</b> GBP 172.00	<b>72.494.XXX</b> GBP 177.00
300 (279)	<b>72.102.XXX</b> GBP 159.00	<b>72.212.XXX</b> GBP 160.00	<b>72.322.XXX</b> GBP 161.00	<b>72.432.XXX</b> GBP 179.00	<b>72.495.XXX</b> GBP 184.00

## The Lista drawer safety catch

### Standard

Standard model without drawer-locking facility.

### Safety catch on the right

Mobile cabinets must be fitted with a drawer safety catch. Prevents unintended opening of drawers even when the cabinet is not locked.

### Safety catch on the right and left as well as double safety catch

Increased safety for use on mobile equipment. Safety catch right and left, operated with both hands. Double catch centrally operated with one hand.

### Lilo locking device

The Lilo locking device (Lock-in – Lock-out) blocks the drawer in an open or closed state. A significant security and comfort benefit, especially for heavy loads.

## The Lista standard colours (without extra charge)

Please complete the last 3 digits of your product code (.XXX) with the desired colour code.

<b>.010</b>	<b>.020</b>	<b>.030</b>	<b>.040</b>	<b>.050</b>	<b>.060</b>	<b>.070</b>	<b>.080</b>	<b>.090</b>	<b>.100</b>
Light blue RAL 5012	Light grey RAL 7035	Reseda green RAL 6011	Capri blue RAL 5019	Grey metallic NCS S 6502-B	Black NCS S 9000-N	Ruby red RAL 3003	Pigeon grey NCS S 4502-B	Gentian blue RAL 5010	Signal blue RAL 5005

## Housing accessories Lista Premium

Width 1193 mm, depth 725 mm (64 x 36E)

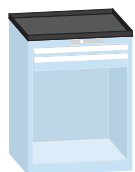

### Cover

Available with or without raised edging. Colour: black.

#### Designation

Ribbed mat, single, black	<b>74.021.000</b> GBP 35.00
Retainer top with raised edges, 3-sided, incl. ribbed mat (black)	<b>74.032.000</b> GBP 88.00



### Base

To adjust the height. Colour: black.

Liftable base: This allows the cabinet to be moved with a forklift truck. Colour: black.

#### Designation

Housing base, black, height 50 mm	<b>74.059.000</b> GBP 51.00
Liftable housing base, black, height 100 mm	<b>74.065.000</b> GBP 60.00
Base cover, black, for liftable base	<b>74.069.000</b> GBP 18.00



### Mobile model

Raised edging, 4-sided, incl. ribbed mat, black, 2 steering castors with stops, 2 support castors, max. load capacity 400 kg, with either nylon or rubber wheels, 1 pushing handle.

#### Designation

Retainer top with raised edges, 4-sided, incl. ribbed mat (black) and push handle	<b>74.043.000</b> GBP 120.00
Pair of castor supports, with nylon roller set ø 100 mm	<b>74.080.000</b> GBP 64.00
Pair of castor supports, with rubber roller set ø 100 mm	<b>74.081.000</b> GBP 85.00
Pair of castor supports, with rubber roller set ø 160 mm	<b>74.082.000</b> GBP 131.00

## Partition material Lista Premium

Useable drawer dimension 1088 x 612 mm (64 x 36E)

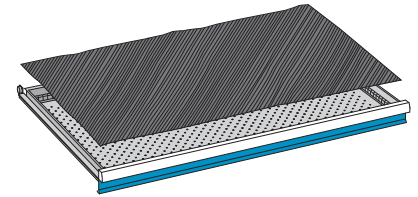
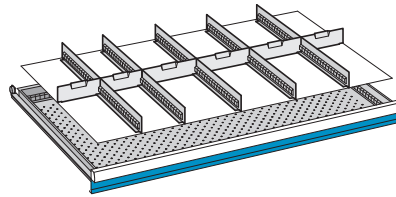
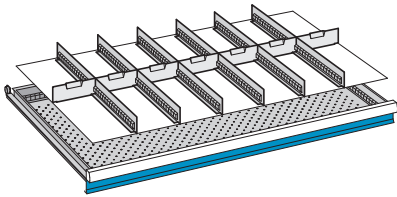

### Dividers

#### For front height mm

75	<b>80.600.000</b> GBP 23.00
100, 125	<b>80.601.000</b> GBP 30.50
150	<b>80.602.000</b> GBP 37.00

6 slotted partitions: 36E  
6 dividers: 9E  
1 divider: 10E

### Dividers

#### For front height mm

75	<b>80.603.000</b> GBP 19.80
100, 125	<b>80.604.000</b> GBP 26.00
150	<b>80.605.000</b> GBP 31.50

5 slotted partitions: 36E  
2 dividers: 9E  
3 dividers: 12E  
1 divider: 10E

### Anti-slide mat

#### Designation

Anti-slide mat anthracite	<b>119.028.000</b> GBP 9.00
Coating: special soft PVC foam. Extremely hardwearing and tear-proof.	

### Lista Script labels for partition material

Label size mm	Used for	Number	
47 x 18	Plastic boxes, clip-on label holders	2 sheets (A4), 52 labels each	<b>18.785.000</b> GBP 1.60
47 x 12	Plastic boxes, clip-on label holders	2 sheets (A4), 76 labels each	<b>18.786.000</b> GBP 1.60
27 x 12	Plastic boxes, clip-on label holders	2 sheets (A4), 133 labels each	<b>18.787.000</b> GBP 1.60

### Lista Script labels for cabinet labelling

Label size mm	Used for	Number	
210 x 22 / 70 x 22	Drawer handle, drawer cabinet	5 sheets (A4), 10/30 labels each	<b>18.784.000</b> GBP 2.60

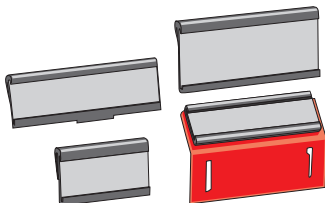

### Clip-on label holders for partition material

Label size mm	Used for	Number	
27 x 12	Trough dividers, dividers, etc.	20 clip-on label holder, 266 labels	<b>134.029.000</b> GBP 7.30
47 x 12	Plastic boxes	20 label holders red	<b>134.034.000</b> GBP 6.80
47 x 12	Dividers, etc.	20 clip-on label holder, 152 labels	<b>134.049.000</b> GBP 7.30
47 x 18	Dividers, etc.	20 clip-on label holder, 104 labels	<b>134.052.000</b> GBP 7.30

## Lista Premium drawer cabinets

Width 1431 mm, depth 725 mm (78 x 36E)

### Configuration examples

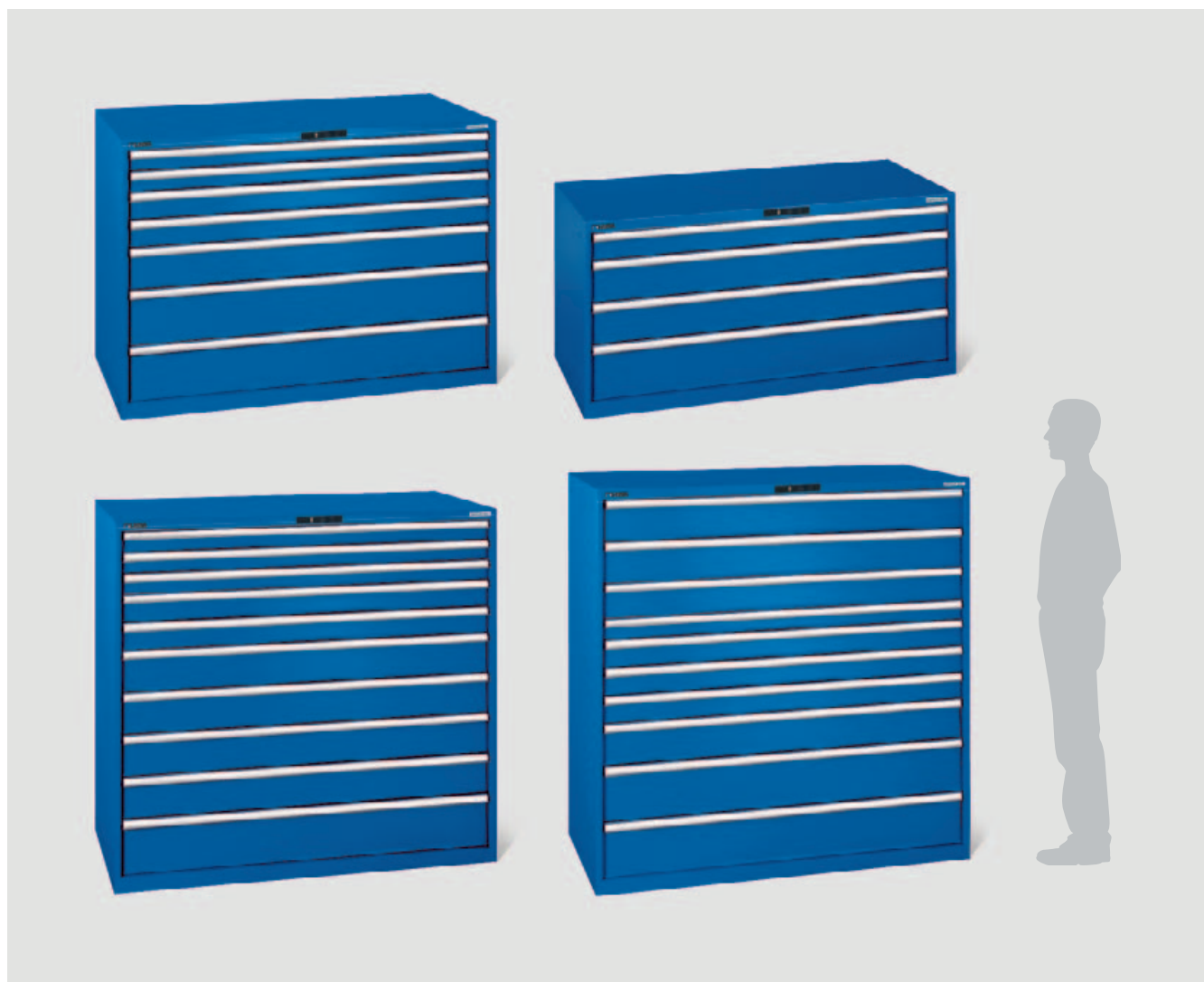

## Lista Premium drawer cabinets

Width 1431 mm, depth 725 mm (78 x 36E)

**Configuration instructions: this is how to put your drawer cabinet together.**

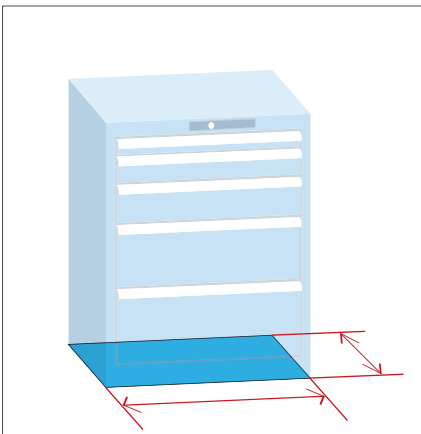

### 1. Selection of the cabinet base area

The first step is the selection of the cabinet base area. It can be indicated in millimetres (width x depth) or Lista units (E x E). The measurements E x E indicate which drawers match which housings.

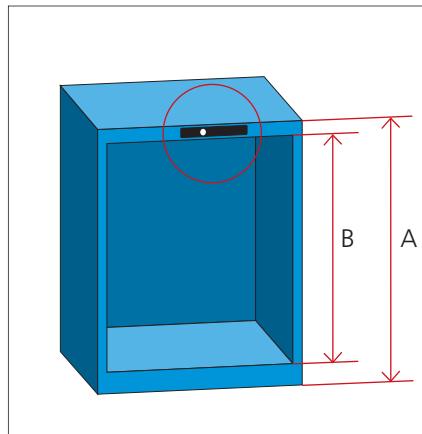

### 2. Selection of housing and locking system

After selecting a base area you can specify the housing. Different heights are available for every floor plan. The selection of housing always includes the choice of the desired locking system and colour.

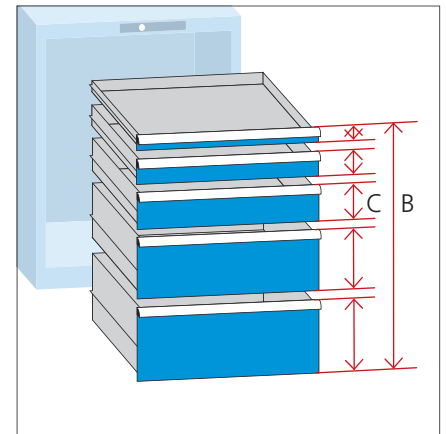

### 3. Selection of drawers

Determine the front height, carrying capacity, and colour of the drawers. The sum total of the front heights C must correspond to the clear height B (refer to figure in point 2). Please also select the type of safety catch.



### 4. Selection of accessories

The drawer cabinet can be combined with cover, base, wheels and push handle for mobile cabinets. Mobile cabinets must be fitted with a drawer safety catch.

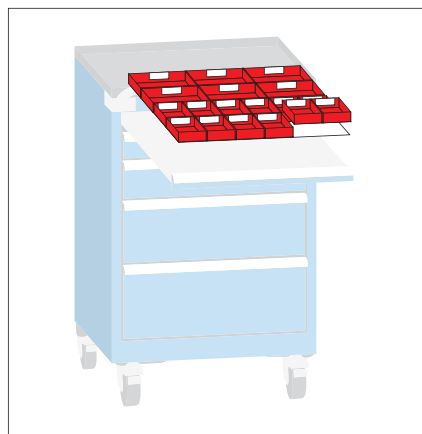

### 5. Selection of partition material

Partition material for drawers is usually ordered as a set. The available selection is large. Please note: The partition material must match the drawer height and useable dimension.

### 6. Determination of the price

The price of the drawer cabinet corresponds to the sum of all selected elements in the corresponding configuration.

## Drawer cabinets Lista Premium

Width 1431 mm, depth 725 mm (78 x 36E)

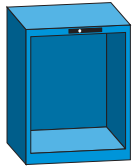

### Housing

Height mm	Clear height mm	Key Lock	Code Lock	Remote Lock	Remote Lock Mobile	Lock without cylinder
700	600	<b>71.114.XXX</b> GBP 326.00	<b>71.173.XXX</b> GBP 366.00	<b>71.232.XXX</b> GBP 481.00	<b>71.273.XXX</b> GBP 551.00	<b>71.055.XXX</b> GBP 317.00
1000	900	<b>71.115.XXX</b> GBP 386.00	<b>71.174.XXX</b> GBP 426.00	<b>71.233.XXX</b> GBP 541.00	<b>71.274.XXX</b> GBP 611.00	<b>71.056.XXX</b> GBP 377.00
1325	1225	<b>71.116.XXX</b> GBP 441.00	<b>71.175.XXX</b> GBP 481.00	<b>71.234.XXX</b> GBP 596.00		<b>71.057.XXX</b> GBP 432.00
1450	1350	<b>71.117.XXX</b> GBP 471.00	<b>71.176.XXX</b> GBP 511.00	<b>71.235.XXX</b> GBP 626.00		<b>71.058.XXX</b> GBP 462.00

### Accessories Remote Lock

Designation	
Hand-held radio transmitter	<b>74.092.000</b> GBP 23.00
Programming key	<b>74.093.000</b> GBP 33.00
Adapter	<b>74.094.000</b> GBP 33.00
Extension unit 2-pole, 1850 mm	<b>74.098.000</b> GBP 23.00
Extension unit 4-pole, 1850 mm	<b>74.099.000</b> GBP 25.00

### Accessories drawer cabinet without cylinder

Designation	
Cylinder 2C 1 simultaneously lockable	<b>222.377.000</b> GBP 11.00
Cylinder 2C 2 simultaneously lockable	<b>222.378.000</b> GBP 11.00
Cylinder 2C 3 simultaneously lockable	<b>222.379.000</b> GBP 11.00
Cylinder 2C 4 simultaneously lockable	<b>222.380.000</b> GBP 11.00
Cylinder 2C 5 simultaneously lockable	<b>222.381.000</b> GBP 11.00
Cylinder 2C 6 simultaneously lockable	<b>222.382.000</b> GBP 11.00
Cylinder 2C _ simultaneously lockable	<b>222.383.000</b> GBP 12.00
Cylinder main locking system	<b>222.384.000</b> GBP 16.00

### The Lista housing locks

#### Key Lock

Standard closure with central locking system and Lista cylinder lock, individual lock, with 2 keys.

#### Code Lock

Electronic locking system, a number combination replaces the key. Programmable user codes allow a flexible locking system to be created. Battery powered.

#### Remote Lock

Electronic locking system with hand-held radio transmitter (unlocking through radio pulse). A programming key grants access and authorisation. Interlinking of cabinets possible using interlink elements. Connects to main supply (adapter necessary). Please note: hand-held radio transmitter, programming key and adapter not included. Can be ordered optionally if required.

#### Remote Lock Mobile

Same functionality as Remote Lock, but with rechargeable battery (requirement for mobile model). Hand-held radio transmitter and programming key not included. Can be ordered optionally if required.

#### Lock without cylinder

Lock to be included in complete locking systems (simultaneously or main locking systems). For cylinders ordered with predefined lock numbers (2C 1 – 2C 6) or a freely defined number (2C \_). Should a cylinder not be ordered, the housing will be supplied with a lock cover.

For further information on locking systems see page 17.

### The Lista standard colours (without extra charge)

Please complete the last 3 digits of your product code (.XXX) with the desired colour code.

<b>.010</b>	<b>.020</b>	<b>.030</b>	<b>.040</b>	<b>.050</b>	<b>.060</b>	<b>.070</b>	<b>.080</b>	<b>.090</b>	<b>.100</b>
Light blue RAL 5012	Light grey RAL 7035	Reseda green RAL 6011	Capri blue RAL 5019	Grey metallic NCS S 6502-B	Black NCS S 9000-N	Ruby red RAL 3003	Pigeon grey NCS S 4502-B	Gentian blue RAL 5010	Signal blue RAL 5005

# Drawers Lista Premium

Useable drawer dimension 1326 x 612 mm (78 x 36E)

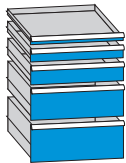

## Drawers 200 kg

Front height mm (useable height)	Standard	Safety catch on the right	Safety catch on the right and left	Double safety catch	Lilo locking device
75 (54)	<b>72.103.XXX</b> GBP 160.00	<b>72.213.XXX</b> GBP 161.00	<b>72.323.XXX</b> GBP 162.00	<b>72.433.XXX</b> GBP 180.00	<b>72.496.XXX</b> GBP 185.00
100 (79)	<b>72.104.XXX</b> GBP 163.00	<b>72.214.XXX</b> GBP 164.00	<b>72.324.XXX</b> GBP 165.00	<b>72.434.XXX</b> GBP 183.00	<b>72.497.XXX</b> GBP 188.00
125 (104)	<b>72.105.XXX</b> GBP 166.00	<b>72.215.XXX</b> GBP 167.00	<b>72.325.XXX</b> GBP 168.00	<b>72.435.XXX</b> GBP 186.00	<b>72.498.XXX</b> GBP 191.00
150 (129)	<b>72.106.XXX</b> GBP 168.00	<b>72.216.XXX</b> GBP 169.00	<b>72.326.XXX</b> GBP 170.00	<b>72.436.XXX</b> GBP 188.00	<b>72.499.XXX</b> GBP 193.00
200 (179)	<b>72.107.XXX</b> GBP 172.00	<b>72.217.XXX</b> GBP 173.00	<b>72.327.XXX</b> GBP 174.00	<b>72.437.XXX</b> GBP 192.00	<b>72.500.XXX</b> GBP 197.00
250 (229)	<b>72.108.XXX</b> GBP 174.00	<b>72.218.XXX</b> GBP 175.00	<b>72.328.XXX</b> GBP 176.00	<b>72.438.XXX</b> GBP 194.00	<b>72.501.XXX</b> GBP 199.00
300 (279)	<b>72.109.XXX</b> GBP 183.00	<b>72.219.XXX</b> GBP 184.00	<b>72.329.XXX</b> GBP 185.00	<b>72.439.XXX</b> GBP 203.00	<b>72.502.XXX</b> GBP 208.00

## The Lista drawer safety catch

### Standard

Standard model without drawer-locking facility.

### Safety catch on the right

Mobile cabinets must be fitted with a drawer safety catch. Prevents unintended opening of drawers even when the cabinet is not locked.

### Safety catch on the right and left as well as double safety catch

Increased safety for use on mobile equipment. Safety catch right and left, operated with both hands. Double catch centrally operated with one hand.

### Lilo locking device

The Lilo locking device (Lock-in – Lock-out) blocks the drawer in an open or closed state. A significant security and comfort benefit, especially for heavy loads.

## The Lista standard colours (without extra charge)

Please complete the last 3 digits of your product code (.XXX) with the desired colour code.

<b>.010</b>	<b>.020</b>	<b>.030</b>	<b>.040</b>	<b>.050</b>	<b>.060</b>	<b>.070</b>	<b>.080</b>	<b>.090</b>	<b>.100</b>
Light blue RAL 5012	Light grey RAL 7035	Reseda green RAL 6011	Capri blue RAL 5019	Grey metallic NCS S 6502-B	Black NCS S 9000-N	Ruby red RAL 3003	Pigeon grey NCS S 4502-B	Gentian blue RAL 5010	Signal blue RAL 5005

## Housing accessories Lista Premium

Width 1431 mm, depth 725 mm (78 x 36E)

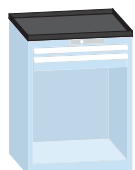

### Cover

Available with or without raised edging. Colour: black.

#### Designation

Ribbed mat, single, black	<b>74.022.000</b> GBP 40.00
Retainer top with raised edges, 3-sided, incl. ribbed mat (black)	<b>74.033.000</b> GBP 98.00



### Base

To adjust the height. Colour: black.

Liftable base: This allows the cabinet to be moved with a forklift truck. Colour: black.

#### Designation

Housing base, black, height 50 mm	<b>74.060.000</b> GBP 55.00
Liftable housing base, black, height 100 mm	<b>74.065.000</b> GBP 60.00
Base cover, black, for liftable base	<b>74.070.000</b> GBP 19.00

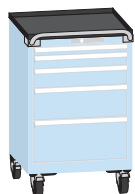

### Mobile model

Raised edging, 4-sided, incl. ribbed mat, black, 2 steering castors with stops, 2 support castors, max. load capacity 400 kg, with either nylon or rubber wheels, 1 pushing handle.

#### Designation

Retainer top with raised edges, 4-sided, incl. ribbed mat (black) and push handle	<b>74.044.000</b> GBP 137.00
Pair of castor supports, with nylon roller set ø 100 mm	<b>74.080.000</b> GBP 64.00
Pair of castor supports, with rubber roller set ø 100 mm	<b>74.081.000</b> GBP 85.00
Pair of castor supports, with rubber roller set ø 160 mm	<b>74.082.000</b> GBP 131.00

# Partition material Lista Premium

Useable drawer dimension 1326 x 612 mm (78 x 36E)

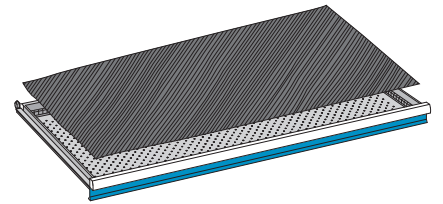
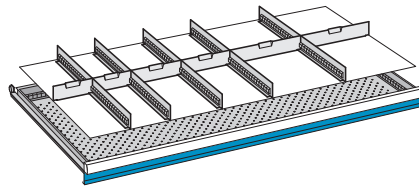
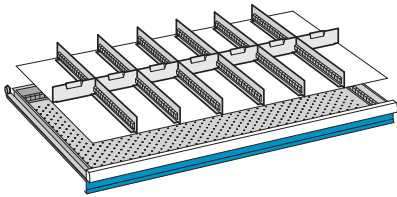

## Dividers

For front height mm	
75	<b>80.553.000</b> GBP 23.50
100, 125	<b>80.554.000</b> GBP 31.00
150	<b>80.555.000</b> GBP 38.00

6 slotted partitions: 36E  
4 dividers: 9E  
2 dividers: 12E  
1 divider: 18E

## Dividers

For front height mm	
75	<b>80.556.000</b> GBP 20.00
100, 125	<b>80.557.000</b> GBP 26.00
150	<b>80.558.000</b> GBP 32.50

5 slotted partitions: 36E  
2 dividers: 9E  
2 dividers: 12E  
2 dividers: 18E

## Anti-slide mat

Designation	
Anti-slide mat anthracite	<b>119.031.000</b> GBP 11.50
Coating: special soft PVC foam. Extremely hardwearing and tear-proof.	

## Lista Script labels for partition material

Label size mm	Used for	Number	
47 x 18	Plastic boxes, clip-on label holders	2 sheets (A4), 52 labels each	<b>18.785.000</b> GBP 1.60
47 x 12	Plastic boxes, clip-on label holders	2 sheets (A4), 76 labels each	<b>18.786.000</b> GBP 1.60
27 x 12	Plastic boxes, clip-on label holders	2 sheets (A4), 133 labels each	<b>18.787.000</b> GBP 1.60

## Lista Script labels for cabinet labelling

Label size mm	Used for	Number	
210 x 22 / 70 x 22	Drawer handle, drawer cabinet	5 sheets (A4), 10/30 labels each	<b>18.784.000</b> GBP 2.60

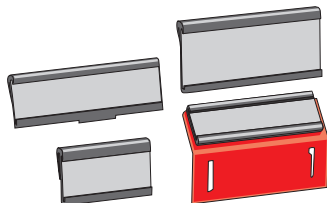

## Clip-on label holders for partition material

Label size mm	Used for	Number	
27 x 12	Trough dividers, dividers, etc.	20 clip-on label holder, 266 labels	<b>134.029.000</b> GBP 7.30
47 x 12	Plastic boxes	20 label holders red	<b>134.034.000</b> GBP 6.80
47 x 12	Dividers, etc.	20 clip-on label holder, 152 labels	<b>134.049.000</b> GBP 7.30
47 x 18	Dividers, etc.	20 clip-on label holder, 104 labels	<b>134.052.000</b> GBP 7.30

## Lista Premium workbenches

Here, everything has its right place

**You and your employees need room for careful working. Requirements differ depending on the area of application. A flexible system meets your needs in regard to quality, efficiency and load: the modular workbench system, Lista Premium.**

### **A broad range of combination possibilities**

Save space, make room, utilise every square centimetre and set up surroundings under and over the work surface which are oriented towards the entire work process. The planning of your workstations is determined very strictly by the needs you define. The selection available on the way to an optimum workstation is extremely broad. It's worth viewing your own needs from the perspective of our specialists. We will be happy to assist you in your order with advice and help.



### **Ergonomic information**

Whether considering the rear panel, working height or labelling: Lista Premium guarantees you an ergonomic workplace designed according to the most up-to-date information.

# Listra Premium workbenches

## Tailor-made for your work



### Workbench leg assemblies

Uniform structural load-bearing capacity is 400 kg. The strong sheet steel construction of our workbenches can take a lot. It was developed by Lista for the attaching of workbench tops, storage shelves and floor anchors. If requested we offer a height-adjustable variation.



### Support pillars

Bearing function: Lista support pillars are mounted directly on the tabletop or stabilisation profile using the included fastening materials (only for bench depth 800 mm). The support pillars made of steel profiles are designed for the holding of components. Plain shelves, container strip mountings or rear panels are available to choose from.



### Shelves with raised edging

More area: The MDF board with three-sided, 8 mm protruding beech raised edging has a colourless priming all round. With the matching bracket made of rectangular steel tubing, your work surface can be additionally vertically adjusted to four levels.



### Drawer cabinets

Everything ready to hand: Proven Lista drawer cabinets are an ideal addition to your workbench.



### Plain shelves and dividers

We offer smooth shelves and also slotted plain shelves for partitioning with dividers. You can also order slip-resistant ribbed mats.



### Container strip mountings and storage bins

These strip mountings can be hooked in simply and are suitable for polyethylene storage bins of the sizes 2, 3 and 4.



### Rear panels

Create more space quickly: Lista rear panels can be hung on the support pillars without screws. Rear panels are perforated to hold tool holders and hooks.

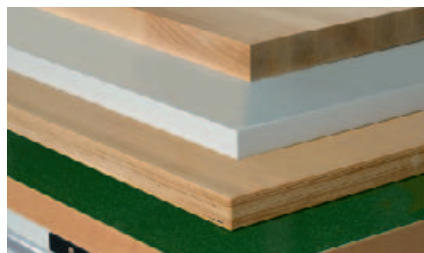

### Diverse tops

Multiplex, beech, urphen or hard laminate tops are available. You'll find a suitable top surface with us for every purpose, each with its own special characteristics and advantages (refer to page 106).



### Storage shelves

The multiplex top for your storage shelf is pre-drilled and includes fastening materials.

## Lista Premium workbenches

### The workbench tops



#### Multiplex top

This workbench top, made of steamed beech veneers, is suitable for general purpose work. It is glued in multiple layers and waterproof. The edges are bevelled, the surfaces are sanded and oiled. The top is splash-proof, dirt-repellent and largely insusceptible to oil and grease.



#### Urphen top

If you need an assembly or inspection station in your workshop, then the workbench top made of pressure-resistant, durable urphen with scratchproof UV coating is the right one for you. Urphen is very durable, splash-proof, dirt-repellent and insusceptible to oil or grease.



#### Beech top

This workbench top, made of steamed beech beams is suitable not only just for heavy-duty work in steel and machine construction, but also as a work surface in metalworking shops, automobile workshops or in schools. It is glued waterproof, the edges are bevelled, the surface is sanded and waxed. The beech top is splash-proof, dirt-repellent and largely insusceptible to oil and grease.

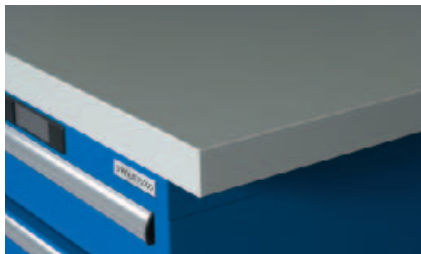

#### Hard laminate top

In the laboratory, electronics area, for the office and desks you can depend on our hard laminate top. It is resistant to most chemicals. Its structured surface is easy to clean. The upper surface with hard laminate is 0.7 mm thick.

#### The following variations are also available:

The multiplex top is also available with a chrome steel surface. Besides for the hard laminate top, a steel edge protection and a rear panel is optionally available for each.

#### Note:

Wood is a natural product. Colour deviations may occur. In conditions of temperature fluctuations or changing humidity, warping of the beech top may take place.

# Listra Premium workbenches

## Combination possibilities

Our workbenches can be combined with various drawer cabinets (hanging or standing). Here we offer an overview of the diverse possibilities.

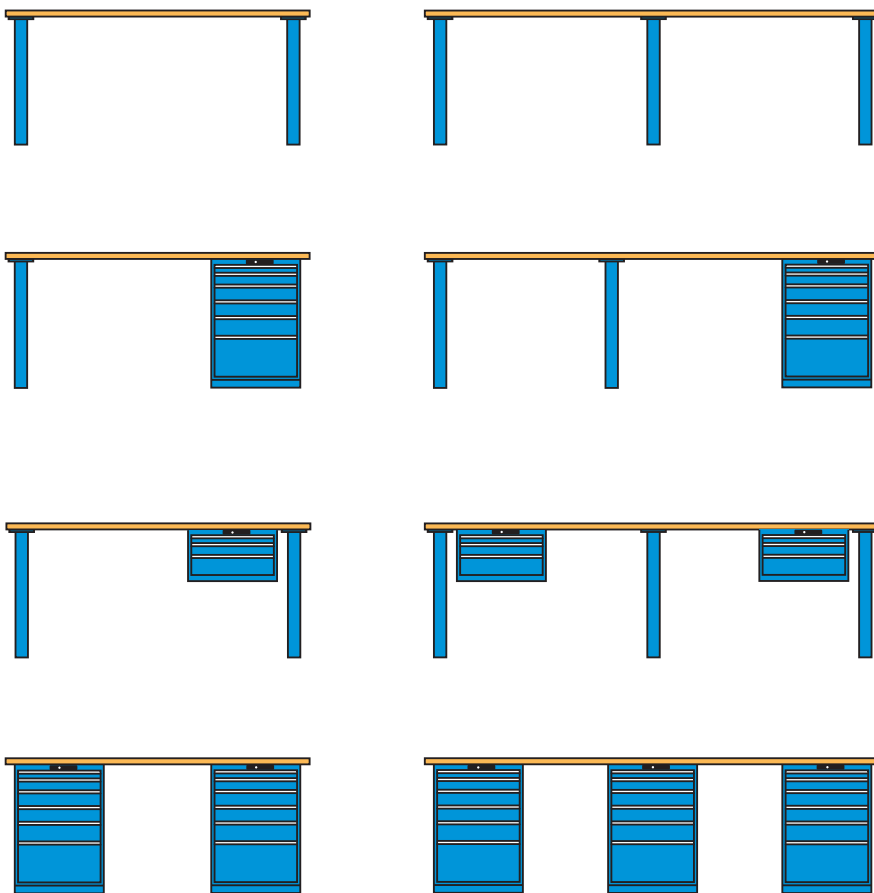

The following combinations of workbench leg assembly and drawer cabinets are possible:

Length mm								
1500	•	•	•	•				
2000	•	•	•	•				
2500				•	•	•	•	
3000					•	•	•	•

The uniform drill-hole scheme of the workbench tops makes many substructure combinations possible. Drawer cabinets with the sizes 27 x 27E, 27 x 36E and 36 x 36E can be positioned both on the left and right. Workbench tops come including both pre-assembly and fastening materials.

## Lista Premium workbenches

### Which drawer cabinet goes with which workbench?

The following tables show which drawer cabinet base area, at which height – either standing or hanging, can be combined with which workbench depth:



Drawer cabinet width 564 mm, depth 572 mm (27 x 27E)

Height mm	Clear height mm	Workbench depth 700 mm	Workbench depth 750 mm	Workbench depth 800 mm
283	200	Hanging		
383	300	Hanging		
533	450	Hanging		
650	550	Standing*		
700	600	Standing		
800	700	Standing		
850	750	Standing		
1000	900	Standing		



Drawer cabinet width 564 mm, depth 725 mm (27 x 36E)

Height mm	Clear height mm	Workbench depth 700 mm	Workbench depth 750 mm	Workbench depth 800 mm
283	200		Hanging	Hanging
383	300		Hanging	Hanging
533	450		Hanging	Hanging
650	550		Standing*	Standing*
700	600		Standing	Standing
800	700		Standing	Standing
850	750		Standing	Standing
1000	900		Standing	Standing



Drawer cabinet width 717 mm, depth 725 mm (36 x 36E)

Height mm	Clear height mm	Workbench depth 700 mm	Workbench depth 750 mm	Workbench depth 800 mm
700	600		Standing	Standing
800	700		Standing	Standing
850	750		Standing	Standing
1000	900		Standing	Standing

\* Drawer cabinet standing; the height 650 mm for a workbench in combination with a leg assembly is only possible with an additional housing base (height 50 mm or 100 mm).

# Lista Premium workbenches

## Dimensions and load-bearing capacity

### Dimensions (all data in millimetres)

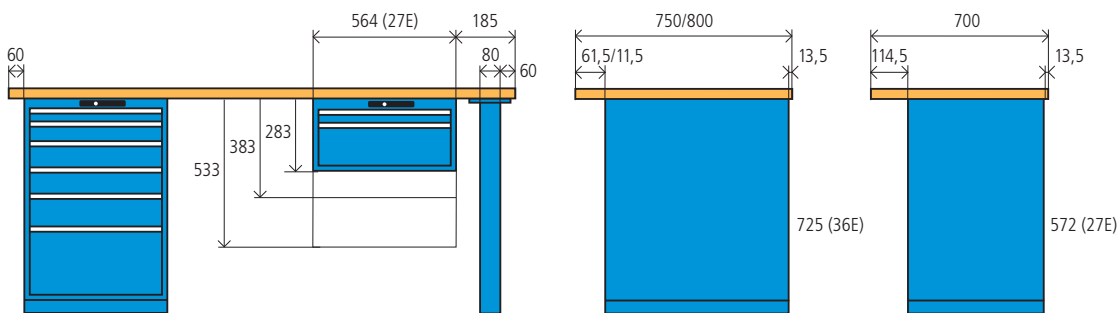

### Load-bearing capacity (These data are valid for both distributed and static loads)

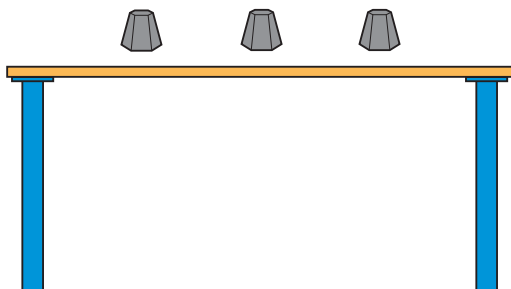

#### Maximum worktop load with 2-leg assemblies

Top material	1500 mm long	2000 mm long
Multiplex 40 mm	600 kg	360 kg
Multiplex 50 mm	1000 kg	500 kg
Beech 50 mm	1000 kg	500 kg
Urphen 50 mm	700 kg	300 kg
Hard Laminate 40 mm	350 kg	

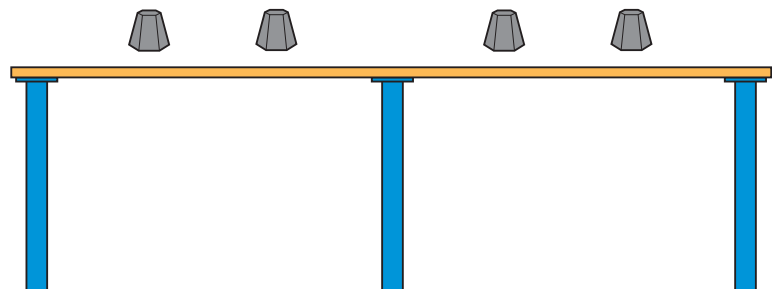

#### Maximum worktop load with 3-leg assemblies

Top material	2500 mm long	3000 mm long
Multiplex 40 mm	1600 kg	1260 kg
Multiplex 50 mm	2000 kg	1600 kg
Beech 50 mm	2000 kg	1600 kg
Urphen 50 mm	1400 kg	1000 kg
Hard Laminate 40 mm	750 kg	

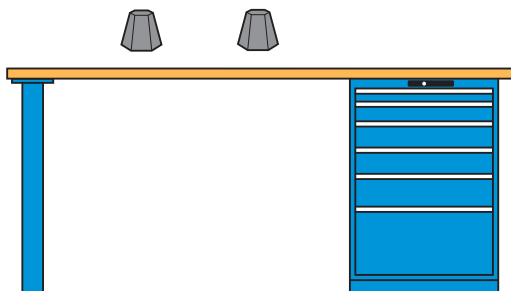

#### Maximum load with 1 cabinet, 1-leg assembly

Top material	1500 mm long	2000 mm long
Multiplex 40 mm	1500 kg	800 kg
Multiplex 50 mm	1500 kg	1000 kg
Beech 50 mm	1500 kg	1000 kg
Urphen 50 mm	1100 kg	700 kg
Hard Laminate 40 mm	650 kg	

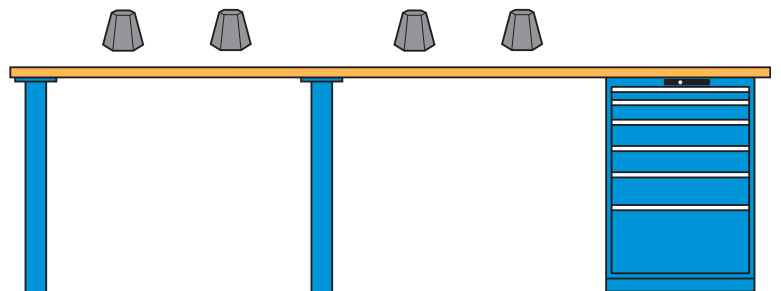

#### Maximum load with 1 cabinet, 2-leg assembly

Top material	2500 mm long	3000 mm long
Multiplex 40 mm	3000 kg	1600 kg
Multiplex 50 mm	3000 kg	2000 kg
Beech 50 mm	3000 kg	2000 kg
Urphen 50 mm	3000 kg	1400 kg
Hard Laminate 40 mm	1100 kg	700 kg

## Lista Premium workbenches Configuration examples



# Listra Premium workbenches

## Configuration instructions

This is how you put your workbench together.

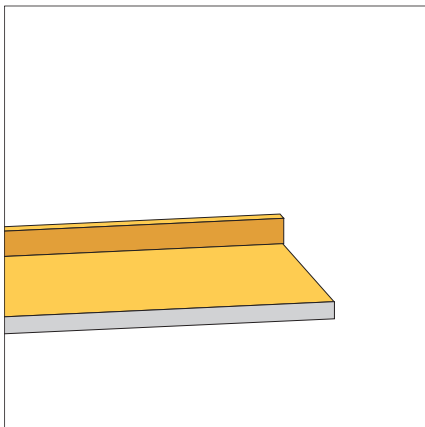

### 1. Selection of the worktop

Select your workbench top with the desired size and materials.



### 2. Selection of substructure

Decide on a suitable substructure, with or without drawer cabinet, with an appropriate height (also possible hanging from worktop).

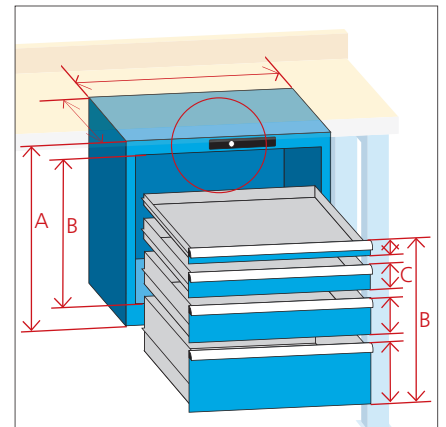

### 3. Selection of the drawer cabinet and drawers

Equip your drawer cabinet as needed. Please also note the configuration tips on the cabinet pages of this catalogue.

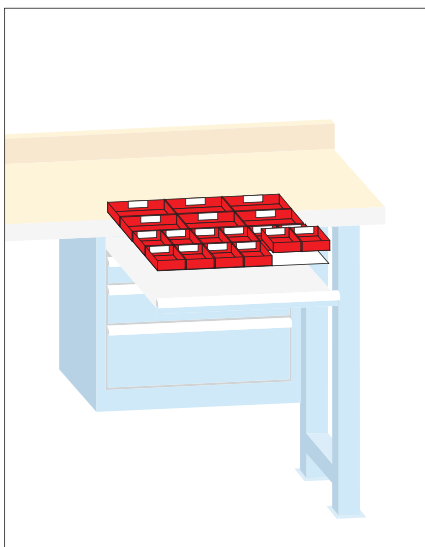

### 4. Selection of partition material

Equip your drawer cabinet completely according to your wishes – individually, drawer for drawer (refer to page 145).

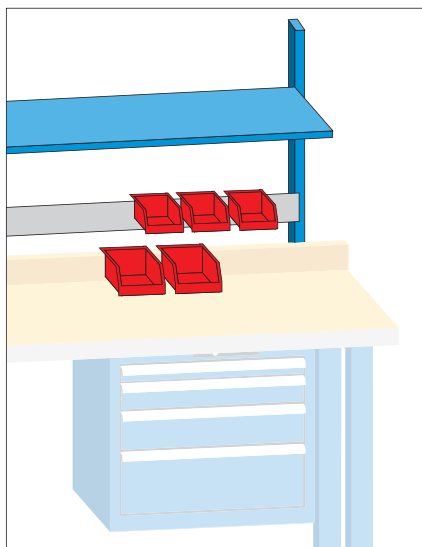

### 5. Selection of the superstructures

Add appropriate accessories from this catalogue to your workbench. Simply ask your Lista partner if you have any questions.

### 6. Determination of the price

The price of the drawer cabinet equals the sum of all selected elements in the configuration made according to your choices.

## Workbench tops Lista Premium Multiplex



### Multiplex top

Incl. pre-assembly and fastening material for substructures.

Length mm	Thickness mm	Workbench depth 700 mm	Workbench depth 750 mm	Workbench depth 800 mm
1500	40	<b>42.044.000</b> GBP 110.00	<b>42.213.000</b> GBP 120.00	<b>42.255.000</b> GBP 130.00
2000	40	<b>42.045.000</b> GBP 150.00	<b>42.214.000</b> GBP 160.00	<b>42.256.000</b> GBP 170.00
2500	40	<b>42.046.000</b> GBP 190.00	<b>42.215.000</b> GBP 200.00	<b>42.257.000</b> GBP 210.00
3000	40	<b>42.047.000</b> GBP 230.00	<b>42.216.000</b> GBP 240.00	<b>42.258.000</b> GBP 250.00
1500	50	<b>42.048.000</b> GBP 140.00	<b>42.217.000</b> GBP 150.00	<b>42.259.000</b> GBP 160.00
2000	50	<b>42.049.000</b> GBP 180.00	<b>42.218.000</b> GBP 190.00	<b>42.260.000</b> GBP 200.00
2500	50	<b>42.050.000</b> GBP 220.00	<b>42.220.000</b> GBP 230.00	<b>42.261.000</b> GBP 240.00
3000	50	<b>42.051.000</b> GBP 260.00	<b>42.221.000</b> GBP 270.00	<b>42.262.000</b> GBP 280.00



### Multiplex top with rear panel

Rear panels are to be screwed to the tabletop. Model: MDF board, 150 mm high, colourless primer.

Incl. pre-assembly and fastening material for substructures.

Length mm	Thickness mm	Workbench depth 700 mm	Workbench depth 750 mm	Workbench depth 800 mm
1500	40	<b>42.052.000</b> GBP 120.00	<b>42.222.000</b> GBP 130.00	<b>42.263.000</b> GBP 140.00
2000	40	<b>42.053.000</b> GBP 160.00	<b>42.224.000</b> GBP 170.00	<b>42.264.000</b> GBP 180.00
2500	40	<b>42.055.000</b> GBP 200.00	<b>42.225.000</b> GBP 210.00	<b>42.265.000</b> GBP 220.00
3000	40	<b>42.090.000</b> GBP 240.00	<b>42.226.000</b> GBP 250.00	<b>42.266.000</b> GBP 260.00
1500	50	<b>42.092.000</b> GBP 150.00	<b>42.227.000</b> GBP 160.00	<b>42.267.000</b> GBP 170.00
2000	50	<b>42.095.000</b> GBP 190.00	<b>42.228.000</b> GBP 200.00	<b>42.269.000</b> GBP 210.00
2500	50	<b>42.098.000</b> GBP 230.00	<b>42.229.000</b> GBP 240.00	<b>42.270.000</b> GBP 250.00
3000	50	<b>42.100.000</b> GBP 270.00	<b>42.230.000</b> GBP 280.00	<b>42.271.000</b> GBP 290.00

# Workbench tops Lista Premium

## Multiplex



### Multiplex top with steel edge

Front edge protector, set into top and completely assembled. Model: made of sheet steel. Colour: grey NCS S 4502-B. Incl. pre-assembly and fastening material for substructures.

Length mm	Thickness mm	Workbench depth 700 mm	Workbench depth 750 mm	Workbench depth 800 mm
1500	40	<b>42.101.000</b> GBP 130.00	<b>42.231.000</b> GBP 140.00	<b>42.272.000</b> GBP 150.00
2000	40	<b>42.104.000</b> GBP 170.00	<b>42.232.000</b> GBP 180.00	<b>42.273.000</b> GBP 190.00
2500	40	<b>42.113.000</b> GBP 210.00	<b>42.233.000</b> GBP 220.00	<b>42.274.000</b> GBP 230.00
3000	40	<b>42.114.000</b> GBP 250.00	<b>42.234.000</b> GBP 260.00	<b>42.275.000</b> GBP 270.00
1500	50	<b>42.138.000</b> GBP 160.00	<b>42.235.000</b> GBP 170.00	<b>42.276.000</b> GBP 180.00
2000	50	<b>42.139.000</b> GBP 200.00	<b>42.236.000</b> GBP 210.00	<b>42.277.000</b> GBP 220.00
2500	50	<b>42.140.000</b> GBP 240.00	<b>42.237.000</b> GBP 250.00	<b>42.278.000</b> GBP 260.00
3000	50	<b>42.141.000</b> GBP 280.00	<b>42.238.000</b> GBP 290.00	<b>42.279.000</b> GBP 300.00

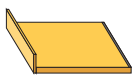

### Multiplex top with rear panel and steel edge

Rear panels are to be screwed to the tabletop. Model: MDF board, 150 mm high, colourless primer. Front edge protector, set into top and completely assembled. Model: made of sheet steel. Colour: grey NCS S 4502-B. Incl. pre-assembly and fastening material for substructures.

Length mm	Thickness mm	Workbench depth 700 mm	Workbench depth 750 mm	Workbench depth 800 mm
1500	40	<b>42.142.000</b> GBP 140.00	<b>42.239.000</b> GBP 150.00	<b>42.306.000</b> GBP 160.00
2000	40	<b>42.143.000</b> GBP 180.00	<b>42.240.000</b> GBP 190.00	<b>42.307.000</b> GBP 200.00
2500	40	<b>42.144.000</b> GBP 220.00	<b>42.241.000</b> GBP 230.00	<b>42.308.000</b> GBP 240.00
3000	40	<b>42.145.000</b> GBP 260.00	<b>42.242.000</b> GBP 270.00	<b>42.309.000</b> GBP 280.00
1500	50	<b>42.146.000</b> GBP 170.00	<b>42.243.000</b> GBP 180.00	<b>42.310.000</b> GBP 190.00
2000	50	<b>42.147.000</b> GBP 210.00	<b>42.244.000</b> GBP 220.00	<b>42.311.000</b> GBP 230.00
2500	50	<b>42.148.000</b> GBP 250.00	<b>42.245.000</b> GBP 260.00	<b>42.312.000</b> GBP 270.00
3000	50	<b>42.149.000</b> GBP 290.00	<b>42.246.000</b> GBP 300.00	<b>42.313.000</b> GBP 310.00

## Workbench tops Lista Premium Multiplex



### Multiplex top with chrome steel sheet covering

Multiplex top with sheet metal cover made of chrome steel, 1.5 mm weight. Incl. pre-assembly and fastening material for substructures.

Length mm	Thickness mm	Workbench depth 700 mm	Workbench depth 750 mm	Workbench depth 800 mm
1500	40	<b>42.150.000</b> GBP 340.00	<b>42.247.000</b> GBP 350.00	<b>42.314.000</b> GBP 360.00
2000	40	<b>42.151.000</b> GBP 390.00	<b>42.248.000</b> GBP 400.00	<b>42.315.000</b> GBP 410.00
2500	40	<b>42.160.000</b> GBP 540.00	<b>42.249.000</b> GBP 550.00	<b>42.316.000</b> GBP 560.00
3000	40	<b>42.169.000</b> GBP 590.00	<b>42.250.000</b> GBP 600.00	<b>42.317.000</b> GBP 610.00
1500	50	<b>42.172.000</b> GBP 370.00	<b>42.251.000</b> GBP 380.00	<b>42.318.000</b> GBP 390.00
2000	50	<b>42.175.000</b> GBP 420.00	<b>42.252.000</b> GBP 430.00	<b>42.319.000</b> GBP 440.00
2500	50	<b>42.209.000</b> GBP 570.00	<b>42.253.000</b> GBP 580.00	<b>42.320.000</b> GBP 590.00
3000	50	<b>42.212.000</b> GBP 620.00	<b>42.254.000</b> GBP 630.00	<b>42.321.000</b> GBP 640.00

# Workbench tops Lista Premium

## Beech



### Beech top

Incl. pre-assembly and fastening material for substructures.

Length mm	Thickness mm	Workbench depth 750 mm	Workbench depth 800 mm
1500	50	<b>42.322.000</b> GBP 190.00	<b>42.423.000</b> GBP 200.00
2000	50	<b>42.323.000</b> GBP 240.00	<b>42.427.000</b> GBP 250.00
2500	50	<b>42.324.000</b> GBP 300.00	<b>42.430.000</b> GBP 320.00
3000	50	<b>42.325.000</b> GBP 350.00	<b>42.433.000</b> GBP 370.00



### Beech top with rear panel

Rear panels are to be screwed to the tabletop. Model: MDF board, 150 mm high, colourless primer. Incl. pre-assembly and fastening material for substructures.

Length mm	Thickness mm	Workbench depth 750 mm	Workbench depth 800 mm
1500	50	<b>42.363.000</b> GBP 200.00	<b>42.436.000</b> GBP 210.00
2000	50	<b>42.364.000</b> GBP 250.00	<b>42.439.000</b> GBP 260.00
2500	50	<b>42.366.000</b> GBP 310.00	<b>42.442.000</b> GBP 330.00
3000	50	<b>42.369.000</b> GBP 360.00	<b>42.445.000</b> GBP 380.00



### Beech top with steel edge

Front edge protector, set into top and completely assembled. Model: made of sheet steel. Colour: grey NCS S 4502-B. Incl. pre-assembly and fastening material for substructures.

Length mm	Thickness mm	Workbench depth 750 mm	Workbench depth 800 mm
1500	50	<b>42.374.000</b> GBP 210.00	<b>42.454.000</b> GBP 220.00
2000	50	<b>42.402.000</b> GBP 260.00	<b>42.455.000</b> GBP 270.00
2500	50	<b>42.403.000</b> GBP 320.00	<b>42.456.000</b> GBP 340.00
3000	50	<b>42.404.000</b> GBP 370.00	<b>42.457.000</b> GBP 390.00



### Beech top with rear panel and steel edge

Rear panels are to be screwed to the tabletop. Model: MDF board, 150 mm high, colourless primer. Front edge protector, set into top and completely assembled. Model: made of sheet steel. Colour: grey NCS S 4502-B. Incl. pre-assembly and fastening material for substructures.

Length mm	Thickness mm	Workbench depth 750 mm	Workbench depth 800 mm
1500	50	<b>42.415.000</b> GBP 220.00	<b>42.458.000</b> GBP 230.00
2000	50	<b>42.420.000</b> GBP 270.00	<b>42.459.000</b> GBP 280.00
2500	50	<b>42.421.000</b> GBP 330.00	<b>42.465.000</b> GBP 350.00
3000	50	<b>42.422.000</b> GBP 380.00	<b>42.466.000</b> GBP 400.00

# Workbench tops Lista Premium

## Urphen



### Urphen top

With hardwood edge all round. Incl. pre-assembly and fastening material for substructures.

Length mm	Thickness mm	Workbench depth 750 mm	Workbench depth 800 mm
1500	50	<b>42.467.XXX</b> GBP 180.00	<b>42.483.XXX</b> GBP 190.00
2000	50	<b>42.468.XXX</b> GBP 230.00	<b>42.484.XXX</b> GBP 240.00
2500	50	<b>42.469.XXX</b> GBP 280.00	<b>42.485.XXX</b> GBP 290.00
3000	50	<b>42.470.XXX</b> GBP 355.00	<b>42.486.XXX</b> GBP 365.00



### Urphen top with rear panel

With hardwood edge, 3-sided. Rear panels are to be screwed to the table-top. Model: MDF board, 150 mm high, colourless primer. Incl. pre-assembly and fastening material for substructures.

Length mm	Thickness mm	Workbench depth 750 mm	Workbench depth 800 mm
1500	50	<b>42.471.XXX</b> GBP 190.00	<b>42.487.XXX</b> GBP 200.00
2000	50	<b>42.472.XXX</b> GBP 240.00	<b>42.488.XXX</b> GBP 250.00
2500	50	<b>42.473.XXX</b> GBP 290.00	<b>42.489.XXX</b> GBP 300.00
3000	50	<b>42.474.XXX</b> GBP 365.00	<b>42.490.XXX</b> GBP 375.00



### Urphen top with steel edge

With hardwood edge, 3-sided. Front edge protector, set into top and completely assembled. Model: made of sheet steel. Colour: grey NCS S 4502-B. Incl. pre-assembly and fastening material for substructures.

Length mm	Thickness mm	Workbench depth 750 mm	Workbench depth 800 mm
1500	50	<b>42.475.XXX</b> GBP 200.00	<b>42.491.XXX</b> GBP 210.00
2000	50	<b>42.476.XXX</b> GBP 250.00	<b>42.492.XXX</b> GBP 260.00
2500	50	<b>42.477.XXX</b> GBP 300.00	<b>42.493.XXX</b> GBP 310.00
3000	50	<b>42.478.XXX</b> GBP 375.00	<b>42.494.XXX</b> GBP 385.00



### Urphen top with rear panel and steel edge

With hardwood edge, 3-sided. Rear panels are to be screwed to the table-top. Model: MDF board, 150 mm high, colourless primer. Edge protector on the front is set into the top and completely assembled. Model: made of sheet steel. Colour: grey NCS S 4502-B. Incl. pre-assembly and fastening material for substructures.

Length mm	Thickness mm	Workbench depth 750 mm	Workbench depth 800 mm
1500	50	<b>42.479.XXX</b> GBP 210.00	<b>42.495.XXX</b> GBP 220.00
2000	50	<b>42.480.XXX</b> GBP 260.00	<b>42.496.XXX</b> GBP 270.00
2500	50	<b>42.481.XXX</b> GBP 310.00	<b>42.497.XXX</b> GBP 320.00
3000	50	<b>42.482.XXX</b> GBP 385.00	<b>42.498.XXX</b> GBP 395.00

### Urphen top colours

Please complete the last 3 digits of your product code (.XXX) with the desired colour code.

<b>.900</b>	<b>.910</b>	<b>.920</b>	<b>.930</b>
Green C	Blue O	Grey K	Red D

# Workbench tops Lista Premium

## Hard laminate



### Hard laminate top

Colour of the laminate upper surface: light grey NCS S 1500-N. Edges covered with grey veneer. Incl. pre-assembly and fastening material for substructures.

Length mm	Thickness mm	Workbench depth 750 mm	Workbench depth 800 mm
1500	40	<b>42.499.000</b> GBP 130.00	<b>42.503.000</b> GBP 160.00
2000	40	<b>42.500.000</b> GBP 160.00	<b>42.504.000</b> GBP 200.00
2500	40	<b>42.501.000</b> GBP 195.00	<b>42.505.000</b> GBP 230.00
3000	40	<b>42.502.000</b> GBP 230.00	<b>42.506.000</b> GBP 250.00

# Substructures for workbenches Lista Premium

## Workbench leg assemblies

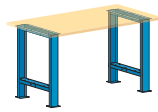

### Workbench leg assembly, height 800 mm, load capacity 400 kg

Sturdy sheet steel construction. With drill holes to attach workbench tops and shelves. Welded-on foot plate prepared for floor anchoring. Uniform structural load bearing: 400 kg.

Width mm	Depth mm	Workbench depth 700 mm	Workbench depth 750 mm	Workbench depth 800 mm
80	675	<b>43.101.XXX</b> GBP 40.00		
80	725		<b>43.111.XXX</b> GBP 45.00	<b>43.111.XXX</b> GBP 45.00

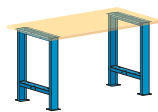

### Workbench leg assembly, height 850 mm, load capacity 400 kg

Sturdy sheet steel construction. With drill holes to attach workbench tops and shelves. Welded-on foot plate prepared for floor anchoring. Uniform structural load bearing: 400 kg.

Width mm	Depth mm	Workbench depth 700 mm	Workbench depth 750 mm	Workbench depth 800 mm
80	675	<b>43.176.XXX</b> GBP 41.00		
80	725		<b>43.179.XXX</b> GBP 46.00	<b>43.179.XXX</b> GBP 46.00

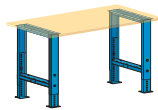

### Workbench leg assembly, height adjustable 700–1050 mm (25-mm increments), load capacity 400 kg

Sturdy sheet steel construction. With drill holes to attach workbench tops and shelves. Welded-on foot plate prepared for floor anchoring. Uniform structural load bearing: 400 kg. Height adjustable in 25-mm increments.

Width mm	Depth mm	Workbench depth 700 mm	Workbench depth 750 mm	Workbench depth 800 mm
80	675	<b>43.186.XXX</b> GBP 45.00		
80	725		<b>43.231.XXX</b> GBP 50.00	<b>43.231.XXX</b> GBP 50.00



### Strut for workbench leg assembly

Struts suitable for workbench leg assembly, in order to increase stability, incl. fastening materials. To be mounted in the middle.

Length mm	Description	Workbench depth 700 mm	Workbench depth 750 mm	Workbench depth 800 mm
1500		<b>43.233.XXX</b> GBP 25.00	<b>43.233.XXX</b> GBP 25.00	<b>43.233.XXX</b> GBP 25.00
2000		<b>43.236.XXX</b> GBP 35.00	<b>43.236.XXX</b> GBP 35.00	<b>43.236.XXX</b> GBP 35.00
2500	2-part	<b>43.241.XXX</b> GBP 50.00	<b>43.241.XXX</b> GBP 50.00	<b>43.241.XXX</b> GBP 50.00
3000	2-part	<b>43.242.XXX</b> GBP 53.00	<b>43.242.XXX</b> GBP 53.00	<b>43.242.XXX</b> GBP 53.00

### The Lista standard colours (without extra charge)

Please complete the last 3 digits of your product code (.XXX) with the desired colour code.

<b>.010</b>	<b>.020</b>	<b>.030</b>	<b>.040</b>	<b>.050</b>	<b>.060</b>	<b>.070</b>	<b>.080</b>	<b>.090</b>	<b>.100</b>
Light blue RAL 5012	Light grey RAL 7035	Reseda green RAL 6011	Capri blue RAL 5019	Grey metallic NCS S 6502-B	Black NCS S 9000-N	Ruby red RAL 3003	Pigeon grey NCS S 4502-B	Gentian blue RAL 5010	Signal blue RAL 5005

# Substructures for workbenches Lista Premium

Drawer cabinets width 564 mm, depth 572 mm (27 x 27E)

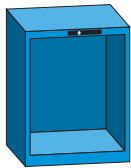

## Housing

Height mm	Clear height mm	Key Lock	Code Lock	Remote Lock	Lock without cylinder
283	200	<b>71.070.XXX</b> GBP 137.00	<b>71.129.XXX</b> GBP 177.00	<b>71.188.XXX</b> GBP 292.00	<b>71.011.XXX</b> GBP 128.00
383	300	<b>71.071.XXX</b> GBP 140.00	<b>71.130.XXX</b> GBP 180.00	<b>71.189.XXX</b> GBP 295.00	<b>71.012.XXX</b> GBP 131.00
533	450	<b>71.072.XXX</b> GBP 150.00	<b>71.131.XXX</b> GBP 190.00	<b>71.190.XXX</b> GBP 305.00	<b>71.013.XXX</b> GBP 141.00
650	550	<b>71.073.XXX</b> GBP 163.00	<b>71.132.XXX</b> GBP 203.00	<b>71.191.XXX</b> GBP 318.00	<b>71.014.XXX</b> GBP 154.00
700	600	<b>71.074.XXX</b> GBP 167.00	<b>71.133.XXX</b> GBP 207.00	<b>71.192.XXX</b> GBP 322.00	<b>71.015.XXX</b> GBP 158.00
800	700	<b>71.075.XXX</b> GBP 174.00	<b>71.134.XXX</b> GBP 214.00	<b>71.193.XXX</b> GBP 329.00	<b>71.016.XXX</b> GBP 165.00
850	750	<b>71.076.XXX</b> GBP 182.00	<b>71.135.XXX</b> GBP 222.00	<b>71.194.XXX</b> GBP 337.00	<b>71.017.XXX</b> GBP 173.00
1000	900	<b>71.077.XXX</b> GBP 198.00	<b>71.136.XXX</b> GBP 238.00	<b>71.195.XXX</b> GBP 353.00	<b>71.018.XXX</b> GBP 189.00

## Accessories Remote Lock

Designation	
Hand-held radio transmitter	<b>74.092.000</b> GBP 23.00
Programming key	<b>74.093.000</b> GBP 33.00
Adapter	<b>74.094.000</b> GBP 33.00
Extension unit 2-pole, 1850 mm	<b>74.098.000</b> GBP 23.00
Extension unit 4-pole, 1850 mm	<b>74.099.000</b> GBP 25.00

## Accessories drawer cabinet without cylinder

Designation	
Cylinder 2C 1 simultaneously lockable	<b>222.377.000</b> GBP 11.00
Cylinder 2C 2 simultaneously lockable	<b>222.378.000</b> GBP 11.00
Cylinder 2C 3 simultaneously lockable	<b>222.379.000</b> GBP 11.00
Cylinder 2C 4 simultaneously lockable	<b>222.380.000</b> GBP 11.00
Cylinder 2C 5 simultaneously lockable	<b>222.381.000</b> GBP 11.00
Cylinder 2C 6 simultaneously lockable	<b>222.382.000</b> GBP 11.00
Cylinder 2C _ simultaneously lockable	<b>222.383.000</b> GBP 12.00
Cylinder main locking system	<b>222.384.000</b> GBP 16.00

## The Lista standard colours (without extra charge)

Please complete the last 3 digits of your product code (.XXX) with the desired colour code.

<b>.010</b>	<b>.020</b>	<b>.030</b>	<b>.040</b>	<b>.050</b>	<b>.060</b>	<b>.070</b>	<b>.080</b>	<b>.090</b>	<b>.100</b>
Light blue RAL 5012	Light grey RAL 7035	Reseda green RAL 6011	Capri blue RAL 5019	Grey metallic NCS S 6502-B	Black NCS S 9000-N	Ruby red RAL 3003	Pigeon grey NCS S 4502-B	Gentian blue RAL 5010	Signal blue RAL 5005

## The Lista housing locks

### Key Lock

Standard closure with central locking system and Lista cylinder lock, individual lock, with 2 keys.

### Code Lock

Electronic locking system, a number combination replaces the key. Programmable user codes allow a flexible locking system to be created. Battery powered.

### Remote Lock

Electronic locking system with hand-held radio transmitter (unlocking through radio pulse). A programming key grants access and authorisation. Interlinking of cabinets possible using interlink elements. Connects to main supply (adapter necessary). Please note: hand-held radio transmitter, programming key and adapter not included. Can be ordered optionally if required.

### Lock without cylinder

Lock to be included in complete locking systems (simultaneously or main locking systems). For cylinders ordered with predefined lock numbers (2C 1 – 2C 6) or a freely defined number (2C \_). Should a cylinder not be ordered, the housing will be supplied with a lock cover.

For further information on locking systems see page 17.

# Substructures for workbenches Lista Premium

## Drawers 27 x 27E

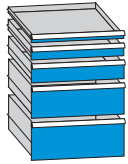

### Drawers 75 kg

Front height mm (useable height)	Standard	Safety catch on the right	Safety catch on the right and left	Double safety catch	Lilo locking device
50 (29)	<b>72.012.XXX</b> GBP 52.00	<b>72.122.XXX</b> GBP 53.00	<b>72.232.XXX</b> GBP 54.00	<b>72.342.XXX</b> GBP 72.00	
75 (54)	<b>72.013.XXX</b> GBP 59.00	<b>72.123.XXX</b> GBP 60.00	<b>72.233.XXX</b> GBP 61.00	<b>72.343.XXX</b> GBP 79.00	
100 (79)	<b>72.015.XXX</b> GBP 60.00	<b>72.125.XXX</b> GBP 61.00	<b>72.235.XXX</b> GBP 62.00	<b>72.345.XXX</b> GBP 80.00	
125 (104)	<b>72.017.XXX</b> GBP 62.00	<b>72.127.XXX</b> GBP 63.00	<b>72.237.XXX</b> GBP 64.00	<b>72.347.XXX</b> GBP 82.00	
150 (129)	<b>72.019.XXX</b> GBP 66.00	<b>72.129.XXX</b> GBP 67.00	<b>72.239.XXX</b> GBP 68.00	<b>72.349.XXX</b> GBP 86.00	
200 (179)	<b>72.021.XXX</b> GBP 73.00	<b>72.131.XXX</b> GBP 74.00	<b>72.241.XXX</b> GBP 75.00	<b>72.351.XXX</b> GBP 93.00	
250 (229)	<b>72.023.XXX</b> GBP 79.00	<b>72.133.XXX</b> GBP 80.00	<b>72.243.XXX</b> GBP 81.00	<b>72.353.XXX</b> GBP 99.00	
300 (279)	<b>72.025.XXX</b> GBP 85.00	<b>72.135.XXX</b> GBP 86.00	<b>72.245.XXX</b> GBP 87.00	<b>72.355.XXX</b> GBP 105.00	

### Drawers 200 kg

Front height mm (useable height)	Standard	Safety catch on the right	Safety catch on the right and left	Double safety catch	Lilo locking device
75 (54)	<b>72.014.XXX</b> GBP 79.00	<b>72.124.XXX</b> GBP 80.00	<b>72.234.XXX</b> GBP 81.00	<b>72.344.XXX</b> GBP 99.00	<b>72.440.XXX</b> GBP 104.00
100 (79)	<b>72.016.XXX</b> GBP 80.00	<b>72.126.XXX</b> GBP 81.00	<b>72.236.XXX</b> GBP 82.00	<b>72.346.XXX</b> GBP 100.00	<b>72.441.XXX</b> GBP 105.00
125 (104)	<b>72.018.XXX</b> GBP 82.00	<b>72.128.XXX</b> GBP 83.00	<b>72.238.XXX</b> GBP 84.00	<b>72.348.XXX</b> GBP 102.00	<b>72.442.XXX</b> GBP 107.00
150 (129)	<b>72.020.XXX</b> GBP 86.00	<b>72.130.XXX</b> GBP 87.00	<b>72.240.XXX</b> GBP 88.00	<b>72.350.XXX</b> GBP 106.00	<b>72.443.XXX</b> GBP 111.00
200 (179)	<b>72.022.XXX</b> GBP 93.00	<b>72.132.XXX</b> GBP 94.00	<b>72.242.XXX</b> GBP 95.00	<b>72.352.XXX</b> GBP 113.00	<b>72.444.XXX</b> GBP 118.00
250 (229)	<b>72.024.XXX</b> GBP 99.00	<b>72.134.XXX</b> GBP 100.00	<b>72.244.XXX</b> GBP 101.00	<b>72.354.XXX</b> GBP 119.00	<b>72.445.XXX</b> GBP 124.00
300 (279)	<b>72.026.XXX</b> GBP 105.00	<b>72.136.XXX</b> GBP 106.00	<b>72.246.XXX</b> GBP 107.00	<b>72.356.XXX</b> GBP 125.00	<b>72.446.XXX</b> GBP 130.00

### The Lista drawer safety catch

#### Standard

Standard model without drawer-locking facility.

#### Safety catch on the right

Mobile cabinets must be fitted with a drawer safety catch. Prevents unintended opening of drawers even when the cabinet is not locked.

#### Safety catch on the right and left as well as double safety catch

Increased safety for use on mobile equipment. Safety catch right and left, operated with both hands. Double catch centrally operated with one hand.

#### Lilo locking device

The Lilo locking device (Lock-in – Lock-out) blocks the drawer in an open or closed state. A significant security and comfort benefit, especially for heavy loads.

### The Lista standard colours (without extra charge)

Please complete the last 3 digits of your product code (.XXX) with the desired colour code.

<b>.010</b>	<b>.020</b>	<b>.030</b>	<b>.040</b>	<b>.050</b>	<b>.060</b>	<b>.070</b>	<b>.080</b>	<b>.090</b>	<b>.100</b>
Light blue RAL 5012	Light grey RAL 7035	Reseda green RAL 6011	Capri blue RAL 5019	Grey metallic NCS S 6502-B	Black NCS S 9000-N	Ruby red RAL 3003	Pigeon grey NCS S 4502-B	Gentian blue RAL 5010	Signal blue RAL 5005

# Substructures for workbenches Lista Premium

## Hinged doors and housing accessories 27 x 27E



### Door mounted on the right

As front closure for the pull-out and adjustable shelves installed in the housing under the drawers. The sum total of the door front height together with all drawer front heights must equal the height clearance of the cabinet housing. Model: made of sheet steel. Colour: see colour chart page 11.

Height mm	Description	
450	With cylinder lock	<b>74.002.XXX</b> GBP 64.00
600	With cylinder lock	<b>74.003.XXX</b> GBP 69.00

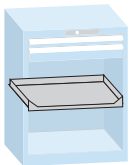

### Pull-out shelf, load capacity 75 kg

The 25-mm divisions in the vertical supports of the cabinet housing allow the pull-out shelves to be mounted in the same cabinet housing in any order. Model: made of sheet steel. Colour: grey NCS S 4502-B.

Height mm	
100	<b>74.008.000</b> GBP 65.00



### Adjustable shelf, load capacity 75 kg

The 25-mm divisions in the vertical supports of the cabinet housing allow the shelves to be mounted in the same cabinet housing in any order. Model: made of sheet steel. Colour: grey NCS S 4502-B.

Height mm	
75	<b>74.009.000</b> GBP 28.00



### Base

To adjust the height. Colour: black.

Designation	
Housing base, black, height 50 mm	<b>74.049.000</b> GBP 35.00
Housing base, black, height 100 mm	<b>74.050.000</b> GBP 37.00

# Substructures for workbenches Lista Premium

## Partition material 27 x 27E

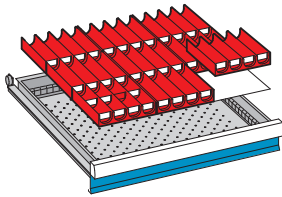

### Troughs

For front height mm	
50	<b>80.656.000</b> GBP 25.50
9 trough-shaped parts: 4 grooves 40 trough dividers: 4 grooves	

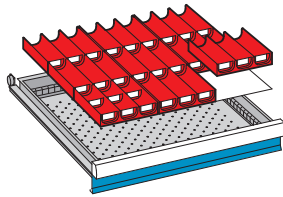

### Troughs

For front height mm	
50	<b>80.657.000</b> GBP 22.50
9 trough-shaped parts: 3 grooves 30 trough dividers: 3 grooves	

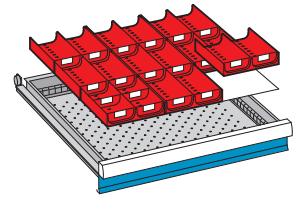

### Troughs

For front height mm	
50	<b>80.658.000</b> GBP 19.50
9 trough-shaped parts: 2 grooves 20 trough dividers: 2 grooves	

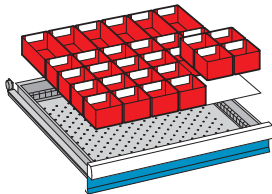

### Plastic boxes

For front height mm	
50	<b>80.659.000</b> GBP 22.80
75	<b>80.660.000</b> GBP 28.50
24 plastic boxes: 75 x 75 mm 6 plastic boxes: 150 x 75 mm	

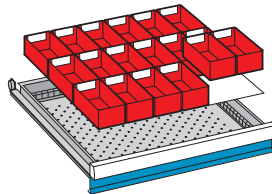

### Plastic boxes

For front height mm	
50	<b>80.661.000</b> GBP 16.00
75	<b>80.662.000</b> GBP 21.50
100, 125	<b>80.663.000</b> GBP 37.50
18 plastic boxes: 150 x 75 mm	

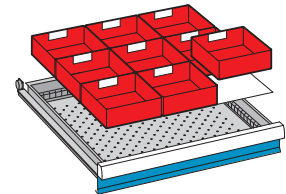

### Plastic boxes

For front height mm	
50	<b>80.664.000</b> GBP 13.80
75	<b>80.665.000</b> GBP 16.50
100, 125	<b>80.666.000</b> GBP 21.50
9 plastic boxes: 150 x 150 mm	

# Substructures for workbenches Lista Premium

## Partition material 27 x 27E

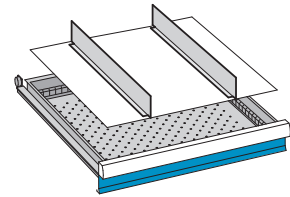
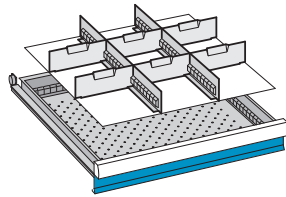
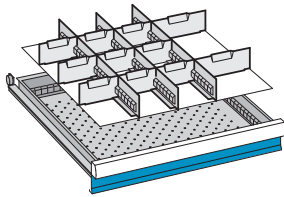

### Dividers

For front height mm	
50	<b>80.667.000</b> GBP 13.30
75	<b>80.668.000</b> GBP 15.00
100, 125	<b>80.669.000</b> GBP 19.50
150	<b>80.670.000</b> GBP 23.50
3 slotted partitions: 27E	
9 dividers: 6E	
2 dividers: 9E	

### Dividers

For front height mm	
50	<b>80.671.000</b> GBP 9.00
75	<b>80.672.000</b> GBP 10.00
100, 125	<b>80.673.000</b> GBP 13.30
150	<b>80.674.000</b> GBP 15.30
200	<b>80.675.000</b> GBP 19.00
250	<b>80.676.000</b> GBP 22.50
300	<b>80.677.000</b> GBP 26.50
2 slotted partitions: 27E	
6 dividers: 9E	

### Dividers

For front height mm	
75	<b>100.315.000</b> GBP 3.60
100, 125	<b>100.130.000</b> GBP 4.50
150	<b>100.131.000</b> GBP 5.80
200	<b>100.132.000</b> GBP 7.30
250	<b>100.133.000</b> GBP 8.80
2 plain partitions: 27E	

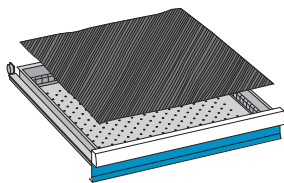

### Anti-slide mat

Designation	
Anti-slide mat anthracite	<b>119.020.000</b> GBP 3.50

Coating: special soft PVC foam.  
Extremely hardwearing and tear-proof.

## Substructures for workbenches Lista Premium

### Partition material 27 x 27E

#### Lista Script labels for partition material

Label size mm	Used for	Number	
47 x 18	Plastic boxes, clip-on label holders	2 sheets (A4), 52 labels each	<b>18.785.000</b> GBP 1.60
47 x 12	Plastic boxes, clip-on label holders	2 sheets (A4), 76 labels each	<b>18.786.000</b> GBP 1.60
27 x 12	Plastic boxes, clip-on label holders	2 sheets (A4), 133 labels each	<b>18.787.000</b> GBP 1.60

#### Lista Script labels for cabinet labelling

Label size mm	Used for	Number	
210 x 22 / 70 x 22	Drawer handle, drawer cabinet	5 sheets (A4), 10/30 labels each	<b>18.784.000</b> GBP 2.60

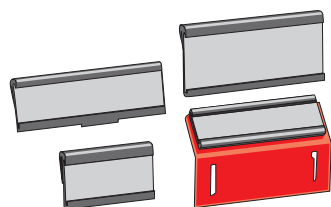

#### Clip-on label holders for partition material

Label size mm	Used for	Number	
27 x 12	Trough dividers, dividers, etc.	20 clip-on label holder, 266 labels	<b>134.029.000</b> GBP 7.30
47 x 12	Plastic boxes	20 label holders red	<b>134.034.000</b> GBP 6.80
47 x 12	Dividers, etc.	20 clip-on label holder, 152 labels	<b>134.049.000</b> GBP 7.30
47 x 18	Dividers, etc.	20 clip-on label holder, 104 labels	<b>134.052.000</b> GBP 7.30

# Substructures for workbenches Lista Premium

Drawer cabinets width 564 mm, depth 725 mm (27 x 36E)

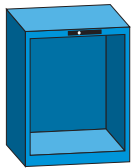

## Housing

Height mm	Clear height mm	Key Lock	Code Lock	Remote Lock	Lock without cylinder
283	200	<b>71.078.XXX</b> GBP 148.00	<b>71.137.XXX</b> GBP 188.00	<b>71.196.XXX</b> GBP 303.00	<b>71.019.XXX</b> GBP 139.00
383	300	<b>71.079.XXX</b> GBP 151.00	<b>71.138.XXX</b> GBP 191.00	<b>71.197.XXX</b> GBP 306.00	<b>71.020.XXX</b> GBP 142.00
533	450	<b>71.080.XXX</b> GBP 166.00	<b>71.139.XXX</b> GBP 206.00	<b>71.198.XXX</b> GBP 321.00	<b>71.021.XXX</b> GBP 157.00
650	550	<b>71.081.XXX</b> GBP 184.00	<b>71.140.XXX</b> GBP 224.00	<b>71.199.XXX</b> GBP 339.00	<b>71.022.XXX</b> GBP 175.00
700	600	<b>71.082.XXX</b> GBP 187.00	<b>71.141.XXX</b> GBP 227.00	<b>71.200.XXX</b> GBP 342.00	<b>71.023.XXX</b> GBP 178.00
800	700	<b>71.083.XXX</b> GBP 199.00	<b>71.142.XXX</b> GBP 239.00	<b>71.201.XXX</b> GBP 354.00	<b>71.024.XXX</b> GBP 190.00
850	750	<b>71.084.XXX</b> GBP 206.00	<b>71.143.XXX</b> GBP 246.00	<b>71.202.XXX</b> GBP 361.00	<b>71.025.XXX</b> GBP 197.00
1000	900	<b>71.085.XXX</b> GBP 223.00	<b>71.144.XXX</b> GBP 263.00	<b>71.203.XXX</b> GBP 378.00	<b>71.026.XXX</b> GBP 214.00

## Accessories Remote Lock

Designation	
Hand-held radio transmitter	<b>74.092.000</b> GBP 23.00
Programming key	<b>74.093.000</b> GBP 33.00
Adapter	<b>74.094.000</b> GBP 33.00
Extension unit 2-pole, 1850 mm	<b>74.098.000</b> GBP 23.00
Extension unit 4-pole, 1850 mm	<b>74.099.000</b> GBP 25.00

## Accessories drawer cabinet without cylinder

Designation	
Cylinder 2C 1 simultaneously lockable	<b>222.377.000</b> GBP 11.00
Cylinder 2C 2 simultaneously lockable	<b>222.378.000</b> GBP 11.00
Cylinder 2C 3 simultaneously lockable	<b>222.379.000</b> GBP 11.00
Cylinder 2C 4 simultaneously lockable	<b>222.380.000</b> GBP 11.00
Cylinder 2C 5 simultaneously lockable	<b>222.381.000</b> GBP 11.00
Cylinder 2C 6 simultaneously lockable	<b>222.382.000</b> GBP 11.00
Cylinder 2C _ simultaneously lockable	<b>222.383.000</b> GBP 12.00
Cylinder main locking system	<b>222.384.000</b> GBP 16.00

## The Lista standard colours (without extra charge)

Please complete the last 3 digits of your product code (.XXX) with the desired colour code.

<b>.010</b>	<b>.020</b>	<b>.030</b>	<b>.040</b>	<b>.050</b>	<b>.060</b>	<b>.070</b>	<b>.080</b>	<b>.090</b>	<b>.100</b>
Light blue RAL 5012	Light grey RAL 7035	Reseda green RAL 6011	Capri blue RAL 5019	Grey metallic NCS S 6502-B	Black NCS S 9000-N	Ruby red RAL 3003	Pigeon grey NCS S 4502-B	Gentian blue RAL 5010	Signal blue RAL 5005

## The Lista housing locks

### Key Lock

Standard closure with central locking system and Lista cylinder lock, individual lock, with 2 keys.

### Code Lock

Electronic locking system, a number combination replaces the key. Programmable user codes allow a flexible locking system to be created. Battery powered.

### Remote Lock

Electronic locking system with hand-held radio transmitter (unlocking through radio pulse). A programming key grants access and authorisation. Interlinking of cabinets possible using interlink elements. Connects to main supply (adapter necessary). Please note: hand-held radio transmitter, programming key and adapter not included. Can be ordered optionally if required.

### Lock without cylinder

Lock to be included in complete locking systems (simultaneously or main locking systems). For cylinders ordered with predefined lock numbers (2C 1 – 2C 6) or a freely defined number (2C \_). Should a cylinder not be ordered, the housing will be supplied with a lock cover.

For further information on locking systems see page 17.

# Substructures for workbenches Lista Premium

## Drawers 27 x 36E

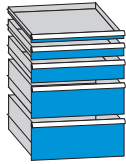

### Drawers 75 kg

Front height mm (useable height)	Standard	Safety catch on the right	Safety catch on the right and left	Double safety catch	Lilo locking device
50 (29)	<b>72.027.XXX</b> GBP 54.00	<b>72.137.XXX</b> GBP 55.00	<b>72.247.XXX</b> GBP 56.00	<b>72.357.XXX</b> GBP 74.00	
75 (54)	<b>72.028.XXX</b> GBP 62.00	<b>72.138.XXX</b> GBP 63.00	<b>72.248.XXX</b> GBP 64.00	<b>72.358.XXX</b> GBP 82.00	
100 (79)	<b>72.030.XXX</b> GBP 65.00	<b>72.140.XXX</b> GBP 66.00	<b>72.250.XXX</b> GBP 67.00	<b>72.360.XXX</b> GBP 85.00	
125 (104)	<b>72.032.XXX</b> GBP 67.00	<b>72.142.XXX</b> GBP 68.00	<b>72.252.XXX</b> GBP 69.00	<b>72.362.XXX</b> GBP 87.00	
150 (129)	<b>72.034.XXX</b> GBP 68.00	<b>72.144.XXX</b> GBP 69.00	<b>72.254.XXX</b> GBP 70.00	<b>72.364.XXX</b> GBP 88.00	
200 (179)	<b>72.036.XXX</b> GBP 78.00	<b>72.146.XXX</b> GBP 79.00	<b>72.256.XXX</b> GBP 80.00	<b>72.366.XXX</b> GBP 98.00	
250 (229)	<b>72.038.XXX</b> GBP 83.00	<b>72.148.XXX</b> GBP 84.00	<b>72.258.XXX</b> GBP 85.00	<b>72.368.XXX</b> GBP 103.00	
300 (279)	<b>72.040.XXX</b> GBP 89.00	<b>72.150.XXX</b> GBP 90.00	<b>72.260.XXX</b> GBP 91.00	<b>72.370.XXX</b> GBP 109.00	

### Drawers 200 kg

Front height mm (useable height)	Standard	Safety catch on the right	Safety catch on the right and left	Double safety catch	Lilo locking device
75 (54)	<b>72.029.XXX</b> GBP 82.00	<b>72.139.XXX</b> GBP 83.00	<b>72.249.XXX</b> GBP 84.00	<b>72.359.XXX</b> GBP 102.00	<b>72.447.XXX</b> GBP 107.00
100 (79)	<b>72.031.XXX</b> GBP 85.00	<b>72.141.XXX</b> GBP 86.00	<b>72.251.XXX</b> GBP 87.00	<b>72.361.XXX</b> GBP 105.00	<b>72.448.XXX</b> GBP 110.00
125 (104)	<b>72.033.XXX</b> GBP 87.00	<b>72.143.XXX</b> GBP 88.00	<b>72.253.XXX</b> GBP 89.00	<b>72.363.XXX</b> GBP 107.00	<b>72.449.XXX</b> GBP 112.00
150 (129)	<b>72.035.XXX</b> GBP 88.00	<b>72.145.XXX</b> GBP 89.00	<b>72.255.XXX</b> GBP 90.00	<b>72.365.XXX</b> GBP 108.00	<b>72.450.XXX</b> GBP 113.00
200 (179)	<b>72.037.XXX</b> GBP 98.00	<b>72.147.XXX</b> GBP 99.00	<b>72.257.XXX</b> GBP 100.00	<b>72.367.XXX</b> GBP 118.00	<b>72.451.XXX</b> GBP 123.00
250 (229)	<b>72.039.XXX</b> GBP 103.00	<b>72.149.XXX</b> GBP 104.00	<b>72.259.XXX</b> GBP 105.00	<b>72.369.XXX</b> GBP 123.00	<b>72.452.XXX</b> GBP 128.00
300 (279)	<b>72.041.XXX</b> GBP 109.00	<b>72.151.XXX</b> GBP 110.00	<b>72.261.XXX</b> GBP 111.00	<b>72.371.XXX</b> GBP 129.00	<b>72.453.XXX</b> GBP 134.00

### The Lista drawer safety catch

#### Standard

Standard model without drawer-locking facility.

#### Safety catch on the right

Mobile cabinets must be fitted with a drawer safety catch. Prevents unintended opening of drawers even when the cabinet is not locked.

#### Safety catch on the right and left as well as double safety catch

Increased safety for use on mobile equipment. Safety catch right and left, operated with both hands. Double catch centrally operated with one hand.

#### Lilo locking device

The Lilo locking device (Lock-in – Lock-out) blocks the drawer in an open or closed state. A significant security and comfort benefit, especially for heavy loads.

### The Lista standard colours (without extra charge)

Please complete the last 3 digits of your product code (.XXX) with the desired colour code.

<b>.010</b>	<b>.020</b>	<b>.030</b>	<b>.040</b>	<b>.050</b>	<b>.060</b>	<b>.070</b>	<b>.080</b>	<b>.090</b>	<b>.100</b>
Light blue RAL 5012	Light grey RAL 7035	Reseda green RAL 6011	Capri blue RAL 5019	Grey metallic NCS S 6502-B	Black NCS S 9000-N	Ruby red RAL 3003	Pigeon grey NCS S 4502-B	Gentian blue RAL 5010	Signal blue RAL 5005

# Substructures for workbenches Lista Premium

## Hinged doors and housing accessories 27 x 36E

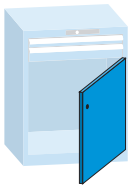

### Door mounted on the right

As front closure for the pull-out and adjustable shelves installed in the housing under the drawers. The sum total of the door front height together with all drawer front heights must equal the height clearance of the cabinet housing. Model: made of sheet steel. Colour: see colour chart page 11.

Height mm	Description	
450	With cylinder lock	<b>74.002.XXX</b> GBP 64.00
600	With cylinder lock	<b>74.003.XXX</b> GBP 69.00

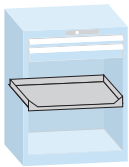

### Pull-out shelf, load capacity 75 kg

The 25-mm divisions in the vertical supports of the cabinet housing allow the pull-out shelves to be mounted in the same cabinet housing in any order. Model: made of sheet steel. Colour: grey NCS S 4502-B.

Height mm	
100	<b>74.010.000</b> GBP 70.00



### Adjustable shelf, load capacity 75 kg

The 25-mm divisions in the vertical supports of the cabinet housing allow the shelves to be mounted in the same cabinet housing in any order. Model: made of sheet steel. Colour: grey NCS S 4502-B.

Height mm	
75	<b>74.011.000</b> GBP 30.00



### Base

To adjust the height. Colour: black.

Designation	
Housing base, black, height 50 mm	<b>74.051.000</b> GBP 36.00
Housing base, black, height 100 mm	<b>74.052.000</b> GBP 38.00

# Substructures for workbenches Lista Premium

## Partition material 27 x 36E

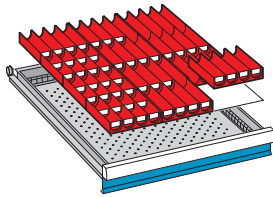

### Troughs

For front height mm	
50	<b>100.283.000</b> GBP 33.50

12 trough-shaped parts:  
4 grooves  
50 trough dividers: 4 grooves

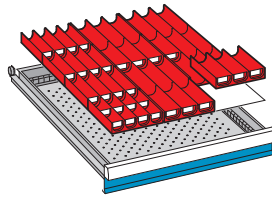

### Troughs

For front height mm	
50	<b>100.284.000</b> GBP 28.50

4 trough-shaped parts: 4 grooves  
20 trough dividers: 4 grooves  
8 trough-shaped parts: 3 grooves  
10 trough dividers: 3 grooves

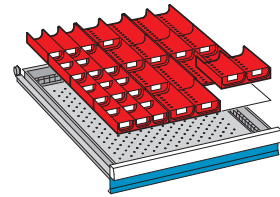

### Troughs

For front height mm	
50	<b>100.286.000</b> GBP 27.00

4 trough-shaped parts: 3 grooves  
20 trough dividers: 3 grooves  
8 trough-shaped parts: 2 grooves  
10 trough dividers: 2 grooves

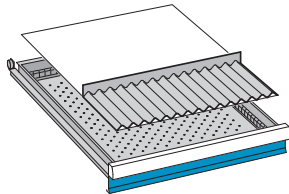

### Corrugated insert

For front height mm	
50	<b>100.295.000</b> GBP 6.30

1 corrugated insert  
1 plain partition: 27E

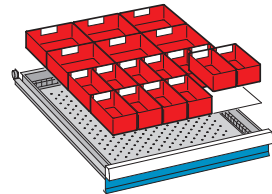

### Plastic boxes

For front height mm	
50	<b>100.292.000</b> GBP 19.80
75	<b>100.293.000</b> GBP 25.50
100, 125	<b>100.294.000</b> GBP 39.50

12 plastic boxes: 150 x 75 mm  
6 plastic boxes: 150 x 150 mm

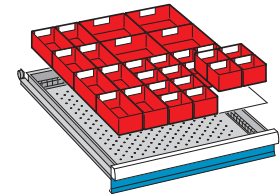

### Plastic boxes

For front height mm	
50	<b>100.290.000</b> GBP 24.80
75	<b>100.291.000</b> GBP 31.00

16 plastic boxes: 75 x 75 mm  
8 plastic boxes: 150 x 75 mm  
4 plastic boxes: 150 x 150 mm

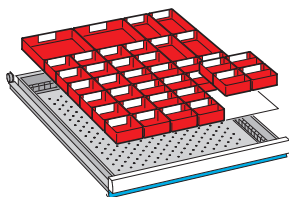

### Plastic boxes

For front height mm	
50	<b>100.288.000</b> GBP 31.00

16 plastic boxes with centre divider: 75 x 75 mm  
16 plastic boxes: 75 x 75 mm  
4 plastic boxes: 150 x 75 mm  
2 plastic boxes: 150 x 150 mm

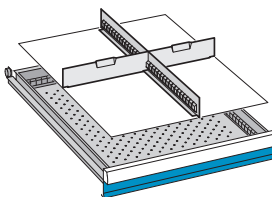

### Dividers

For front height mm	
75	<b>100.270.000</b> GBP 4.80
100, 125	<b>100.271.000</b> GBP 6.00
150	<b>100.272.000</b> GBP 7.50
200	<b>100.273.000</b> GBP 9.50
250	<b>80.691.000</b> GBP 11.50

1 slotted partition: 36E  
1 divider: 12E  
1 divider: 15E

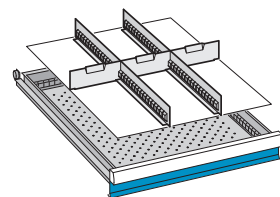

### Dividers

For front height mm	
75	<b>100.275.000</b> GBP 8.30
100, 125	<b>100.276.000</b> GBP 10.80
150	<b>100.277.000</b> GBP 13.00
200	<b>100.278.000</b> GBP 15.30
250	<b>80.692.000</b> GBP 18.50

2 slotted partitions: 36E  
3 dividers: 9E

# Substructures for workbenches Lista Premium

## Partition material 27 x 36E

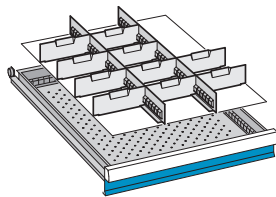

### Dividers

For front height mm	
50	<b>100.244.000</b> GBP 11.80
75	<b>100.245.000</b> GBP 13.30
100, 125	<b>100.246.000</b> GBP 17.00
150	<b>100.247.000</b> GBP 19.50

2 slotted partitions: 36E  
10 dividers: 9E

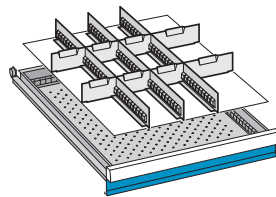

### Dividers

For front height mm	
50	<b>100.249.000</b> GBP 12.30
75	<b>100.250.000</b> GBP 13.80
100, 125	<b>100.251.000</b> GBP 18.00
150	<b>100.252.000</b> GBP 21.80

3 slotted partitions: 36E  
6 dividers: 6E  
2 dividers: 9E

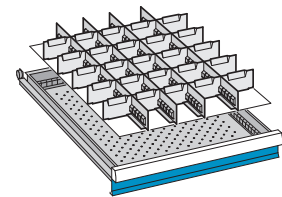

### Dividers

For front height mm	
50	<b>100.234.000</b> GBP 21.80
75	<b>100.235.000</b> GBP 25.50
100, 125	<b>100.236.000</b> GBP 33.00

4 slotted partitions: 36E  
15 dividers: 5E  
10 dividers: 6E

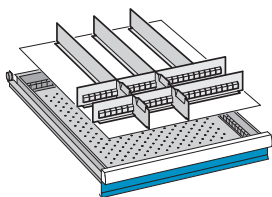

### Dividers

For front height mm	
50	<b>100.254.000</b> GBP 11.50
75	<b>100.255.000</b> GBP 13.00
100, 125	<b>100.256.000</b> GBP 17.00
150	<b>100.257.000</b> GBP 20.50

2 slotted partitions: 27E  
4 dividers: 6E  
3 plain partitions: 24E

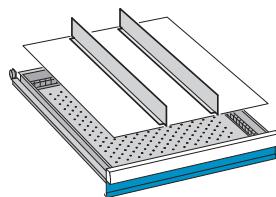

### Dividers

For front height mm	
75	<b>100.265.000</b> GBP 3.80
100, 125	<b>100.266.000</b> GBP 4.90
150	<b>100.267.000</b> GBP 6.00
200	<b>100.268.000</b> GBP 7.50
250	<b>80.695.000</b> GBP 9.30

2 plain partitions: 36E

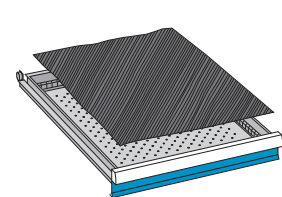

### Anti-slide mat

Designation	
Anti-slide mat anthracite	<b>100.396.000</b> GBP 4.50

Coating: special soft PVC foam.  
Extremely hardwearing and tear-proof.

## Substructures for workbenches Lista Premium

### Partition material 27 x 36E

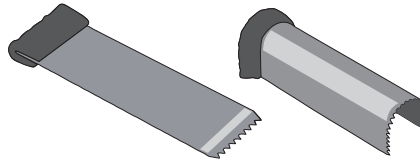
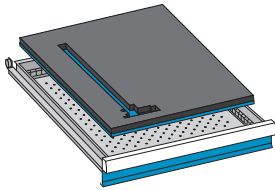

#### PE plastic foam inserts

Designation	
Plastic foam insert, black. Thickness 25 mm	<b>80.917.000</b> GBP 15.30
Underlay blue. Thickness 5 mm	<b>80.906.000</b> GBP 10.00

Pre-cut inserts for the most popular tool sets on page 149.

#### Plunge cutters

Designation	
Plunge cutter 20 mm	<b>80.920.000</b> GBP 2.60
Plunge cutter 50 mm	<b>80.921.000</b> GBP 4.80
Plunge cutter "U" 20 x 20 mm	<b>80.922.000</b> GBP 9.00

Plunge cutter for PE plastic foam inserts.

#### Lista Script labels for partition material

Label size mm	Used for	Number	
47 x 18	Plastic boxes, clip-on label holders	2 sheets (A4), 52 labels each	<b>18.785.000</b> GBP 1.60
47 x 12	Plastic boxes, clip-on label holders	2 sheets (A4), 76 labels each	<b>18.786.000</b> GBP 1.60
27 x 12	Plastic boxes, clip-on label holders	2 sheets (A4), 133 labels each	<b>18.787.000</b> GBP 1.60

#### Lista Script labels for cabinet labelling

Label size mm	Used for	Number	
210 x 22 / 70 x 22	Drawer handle, drawer cabinet	5 sheets (A4), 10/30 labels each	<b>18.784.000</b> GBP 2.60

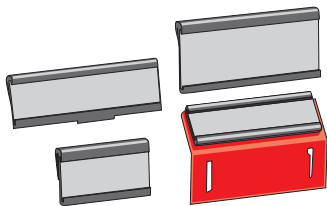

#### Clip-on label holders for partition material

Label size mm	Used for	Number	
27 x 12	Trough dividers, dividers, etc.	20 clip-on label holder, 266 labels	<b>134.029.000</b> GBP 7.30
47 x 12	Plastic boxes	20 label holders red	<b>134.034.000</b> GBP 6.80
47 x 12	Dividers, etc.	20 clip-on label holder, 152 labels	<b>134.049.000</b> GBP 7.30
47 x 18	Dividers, etc.	20 clip-on label holder, 104 labels	<b>134.052.000</b> GBP 7.30

# Substructures for workbenches Lista Premium

Drawer cabinets width 717 mm, depth 725 mm (36 x 36E)

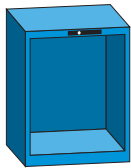

## Housing

Height mm	Clear height mm	Key Lock	Code Lock	Remote Lock	Lock without cylinder
700	600	<b>71.090.XXX</b> GBP 210.00	<b>71.149.XXX</b> GBP 250.00	<b>71.208.XXX</b> GBP 365.00	<b>71.031.XXX</b> GBP 201.00
800	700	<b>71.091.XXX</b> GBP 220.00	<b>71.150.XXX</b> GBP 260.00	<b>71.209.XXX</b> GBP 375.00	<b>71.032.XXX</b> GBP 211.00
850	750	<b>71.092.XXX</b> GBP 229.00	<b>71.151.XXX</b> GBP 269.00	<b>71.210.XXX</b> GBP 384.00	<b>71.033.XXX</b> GBP 220.00
1000	900	<b>71.093.XXX</b> GBP 246.00	<b>71.152.XXX</b> GBP 286.00	<b>71.211.XXX</b> GBP 401.00	<b>71.034.XXX</b> GBP 237.00

## Accessories Remote Lock

Designation	
Hand-held radio transmitter	<b>74.092.000</b> GBP 23.00
Programming key	<b>74.093.000</b> GBP 33.00
Adapter	<b>74.094.000</b> GBP 33.00
Extension unit 2-pole, 1850 mm	<b>74.098.000</b> GBP 23.00
Extension unit 4-pole, 1850 mm	<b>74.099.000</b> GBP 25.00

## Accessories drawer cabinet without cylinder

Designation	
Cylinder 2C 1 simultaneously lockable	<b>222.377.000</b> GBP 11.00
Cylinder 2C 2 simultaneously lockable	<b>222.378.000</b> GBP 11.00
Cylinder 2C 3 simultaneously lockable	<b>222.379.000</b> GBP 11.00
Cylinder 2C 4 simultaneously lockable	<b>222.380.000</b> GBP 11.00
Cylinder 2C 5 simultaneously lockable	<b>222.381.000</b> GBP 11.00
Cylinder 2C 6 simultaneously lockable	<b>222.382.000</b> GBP 11.00
Cylinder 2C _ simultaneously lockable	<b>222.383.000</b> GBP 12.00
Cylinder main locking system	<b>222.384.000</b> GBP 16.00

## The Lista housing locks

### Key Lock

Standard closure with central locking system and Lista cylinder lock, individual lock, with 2 keys.

### Code Lock

Electronic locking system, a number combination replaces the key. Programmable user codes allow a flexible locking system to be created. Battery powered.

### Remote Lock

Electronic locking system with hand-held radio transmitter (unlocking through radio pulse). A programming key grants access and authorisation. Interlinking of cabinets possible using interlink elements. Connects to main supply (adapter necessary). Please note: hand-held radio transmitter, programming key and adapter not included. Can be ordered optionally if required.

### Lock without cylinder

Lock to be included in complete locking systems (simultaneously or main locking systems). For cylinders ordered with predefined lock numbers (2C 1 – 2C 6) or a freely defined number (2C \_). Should a cylinder not be ordered, the housing will be supplied with a lock cover.

For further information on locking systems see page 17.

## The Lista standard colours (without extra charge)

Please complete the last 3 digits of your product code (.XXX) with the desired colour code.

<b>.010</b>	<b>.020</b>	<b>.030</b>	<b>.040</b>	<b>.050</b>	<b>.060</b>	<b>.070</b>	<b>.080</b>	<b>.090</b>	<b>.100</b>
Light blue RAL 5012	Light grey RAL 7035	Reseda green RAL 6011	Capri blue RAL 5019	Grey metallic NCS S 6502-B	Black NCS S 9000-N	Ruby red RAL 3003	Pigeon grey NCS S 4502-B	Gentian blue RAL 5010	Signal blue RAL 5005

# Substructures for workbenches Lista Premium

## Drawers 36 x 36E

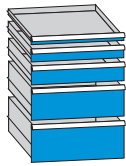

### Drawers 75 kg

Front height mm (useable height)	Standard	Safety catch on the right	Safety catch on the right and left	Double safety catch	Lilo locking device
50 (29)	<b>72.057.XXX</b> GBP 61.00	<b>72.167.XXX</b> GBP 62.00	<b>72.277.XXX</b> GBP 63.00	<b>72.387.XXX</b> GBP 81.00	
75 (54)	<b>72.058.XXX</b> GBP 66.00	<b>72.168.XXX</b> GBP 67.00	<b>72.278.XXX</b> GBP 68.00	<b>72.388.XXX</b> GBP 86.00	
100 (79)	<b>72.060.XXX</b> GBP 69.00	<b>72.170.XXX</b> GBP 70.00	<b>72.280.XXX</b> GBP 71.00	<b>72.390.XXX</b> GBP 89.00	
125 (104)	<b>72.062.XXX</b> GBP 72.00	<b>72.172.XXX</b> GBP 73.00	<b>72.282.XXX</b> GBP 74.00	<b>72.392.XXX</b> GBP 92.00	
150 (129)	<b>72.064.XXX</b> GBP 74.00	<b>72.174.XXX</b> GBP 75.00	<b>72.284.XXX</b> GBP 76.00	<b>72.394.XXX</b> GBP 94.00	
200 (179)	<b>72.066.XXX</b> GBP 84.00	<b>72.176.XXX</b> GBP 85.00	<b>72.286.XXX</b> GBP 86.00	<b>72.396.XXX</b> GBP 104.00	
250 (229)	<b>72.068.XXX</b> GBP 98.00	<b>72.178.XXX</b> GBP 99.00	<b>72.288.XXX</b> GBP 100.00	<b>72.398.XXX</b> GBP 118.00	
300 (279)	<b>72.070.XXX</b> GBP 105.00	<b>72.180.XXX</b> GBP 106.00	<b>72.290.XXX</b> GBP 107.00	<b>72.400.XXX</b> GBP 125.00	

### Drawers 200 kg

Front height mm (useable height)	Standard	Safety catch on the right	Safety catch on the right and left	Double safety catch	Lilo locking device
75 (54)	<b>72.059.XXX</b> GBP 86.00	<b>72.169.XXX</b> GBP 87.00	<b>72.279.XXX</b> GBP 88.00	<b>72.389.XXX</b> GBP 106.00	<b>72.461.XXX</b> GBP 111.00
100 (79)	<b>72.061.XXX</b> GBP 89.00	<b>72.171.XXX</b> GBP 90.00	<b>72.281.XXX</b> GBP 91.00	<b>72.391.XXX</b> GBP 109.00	<b>72.462.XXX</b> GBP 114.00
125 (104)	<b>72.063.XXX</b> GBP 92.00	<b>72.173.XXX</b> GBP 93.00	<b>72.283.XXX</b> GBP 94.00	<b>72.393.XXX</b> GBP 112.00	<b>72.463.XXX</b> GBP 117.00
150 (129)	<b>72.065.XXX</b> GBP 94.00	<b>72.175.XXX</b> GBP 95.00	<b>72.285.XXX</b> GBP 96.00	<b>72.395.XXX</b> GBP 114.00	<b>72.464.XXX</b> GBP 119.00
200 (179)	<b>72.067.XXX</b> GBP 104.00	<b>72.177.XXX</b> GBP 105.00	<b>72.287.XXX</b> GBP 106.00	<b>72.397.XXX</b> GBP 124.00	<b>72.465.XXX</b> GBP 129.00
250 (229)	<b>72.069.XXX</b> GBP 118.00	<b>72.179.XXX</b> GBP 119.00	<b>72.289.XXX</b> GBP 120.00	<b>72.399.XXX</b> GBP 138.00	<b>72.466.XXX</b> GBP 143.00
300 (279)	<b>72.071.XXX</b> GBP 125.00	<b>72.181.XXX</b> GBP 126.00	<b>72.291.XXX</b> GBP 127.00	<b>72.401.XXX</b> GBP 145.00	<b>72.467.XXX</b> GBP 150.00

### The Lista drawer safety catch

#### Standard

Standard model without drawer-locking facility.

#### Safety catch on the right

Mobile cabinets must be fitted with a drawer safety catch. Prevents unintended opening of drawers even when the cabinet is not locked.

#### Safety catch on the right and left as well as double safety catch

Increased safety for use on mobile equipment. Safety catch right and left, operated with both hands. Double catch centrally operated with one hand.

#### Lilo locking device

The Lilo locking device (Lock-in – Lock-out) blocks the drawer in an open or closed state. A significant security and comfort benefit, especially for heavy loads.

### The Lista standard colours (without extra charge)

Please complete the last 3 digits of your product code (.XXX) with the desired colour code.

<b>.010</b>	<b>.020</b>	<b>.030</b>	<b>.040</b>	<b>.050</b>	<b>.060</b>	<b>.070</b>	<b>.080</b>	<b>.090</b>	<b>.100</b>
Light blue RAL 5012	Light grey RAL 7035	Reseda green RAL 6011	Capri blue RAL 5019	Grey metallic NCS S 6502-B	Black NCS S 9000-N	Ruby red RAL 3003	Pigeon grey NCS S 4502-B	Gentian blue RAL 5010	Signal blue RAL 5005

# Substructures for workbenches Lista Premium

## Housing accessories 36 x 36E



### Base

To adjust the height. Colour: black.  
 Liftable base: This allows the cabinet to be moved with a forklift truck. Colour: black.

Designation	
Housing base, black, height 50 mm	<b>74.055.000</b> GBP 39.00
Liftable housing base, black, height 100 mm	<b>74.062.000</b> GBP 60.00
Base cover, black, for liftable base	<b>74.066.000</b> GBP 14.00

# Substructures for workbenches Lista Premium

## Partition material 36 x 36E

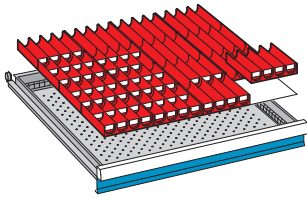

### Troughs

For front height mm	
50	<b>100.317.000</b> GBP 45.50

16 trough-shaped parts:  
4 grooves  
70 trough dividers: 4 grooves

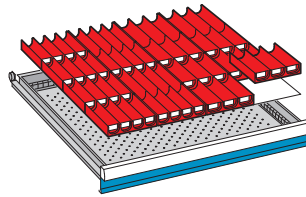

### Troughs

For front height mm	
50	<b>100.318.000</b> GBP 40.00

8 trough-shaped parts: 4 grooves  
30 trough dividers: 4 grooves  
8 trough-shaped parts: 3 grooves  
20 trough dividers: 3 grooves

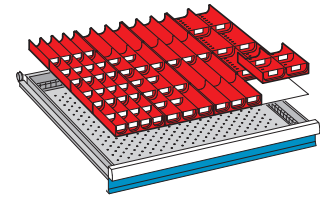

### Troughs

For front height mm	
50	<b>100.319.000</b> GBP 41.50

4 trough-shaped parts: 4 grooves  
30 trough dividers: 4 grooves  
8 trough-shaped parts: 3 grooves  
20 trough dividers: 3 grooves  
4 trough-shaped parts: 2 grooves  
10 trough dividers: 2 grooves

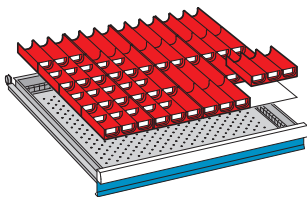

### Troughs

For front height mm	
50	<b>100.320.000</b> GBP 41.50

16 trough-shaped parts:  
3 grooves  
60 trough dividers: 3 grooves

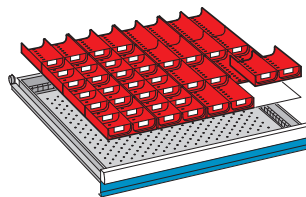

### Troughs

For front height mm	
50	<b>100.322.000</b> GBP 35.50

16 trough-shaped parts:  
2 grooves  
40 trough dividers: 2 grooves

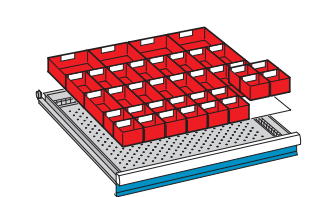

### Plastic boxes

For front height mm	
50	<b>100.380.000</b> GBP 32.00
75	<b>100.381.000</b> GBP 40.50

16 plastic boxes: 75 x 75 mm  
16 plastic boxes: 150 x 75 mm  
4 plastic boxes: 150 x 150 mm

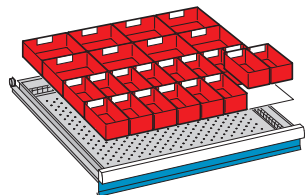

### Plastic boxes

For front height mm	
50	<b>100.389.000</b> GBP 26.50
75	<b>100.390.000</b> GBP 34.00
100, 125	<b>100.391.000</b> GBP 52.50

16 plastic boxes: 150 x 75 mm  
8 plastic boxes: 150 x 150 mm

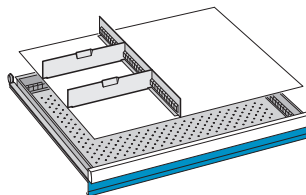

### Dividers

For front height mm	
100, 125	<b>100.354.000</b> GBP 6.30
150	<b>100.355.000</b> GBP 8.30
200	<b>100.356.000</b> GBP 10.30
250	<b>80.688.000</b> GBP 12.30
300	<b>100.357.000</b> GBP 14.00

1 slotted partition: 36E  
2 dividers: 18E

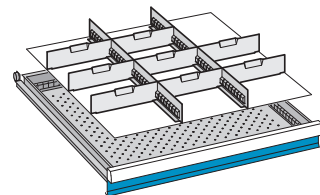

### Dividers

For front height mm	
75	<b>100.348.000</b> GBP 13.00
100, 125	<b>100.349.000</b> GBP 15.80
150	<b>100.350.000</b> GBP 18.80
200	<b>100.351.000</b> GBP 25.00

2 slotted partitions: 36E  
8 dividers: 12E

# Substructures for workbenches Lista Premium

## Partition material 36 x 36E

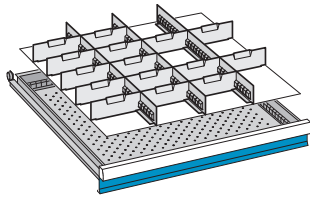

### Dividers

For front height mm	
75	<b>100.343.000</b> GBP 19.80
100, 125	<b>100.344.000</b> GBP 25.50
150	<b>100.345.000</b> GBP 29.50
200	<b>100.346.000</b> GBP 35.50
250	<b>80.689.000</b> GBP 43.00

3 slotted partitions: 36E  
15 dividers: 9E

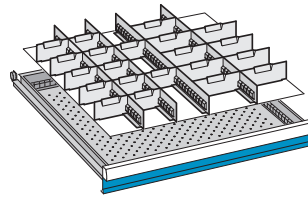

### Dividers

For front height mm	
50	<b>100.333.000</b> GBP 22.00
75	<b>100.334.000</b> GBP 25.50
100, 125	<b>100.335.000</b> GBP 32.50

4 slotted partitions: 36E  
12 dividers: 6E  
9 dividers: 9E

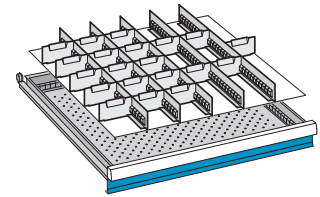

### Dividers

For front height mm	
50	<b>100.329.000</b> GBP 23.00
75	<b>100.330.000</b> GBP 26.50
100, 125	<b>100.331.000</b> GBP 34.00

5 slotted partitions: 36E  
20 dividers: 6E

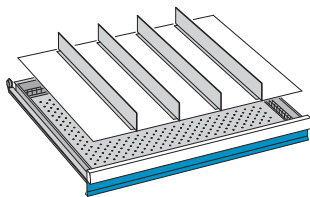

### Dividers

For front height mm	
75	<b>100.368.000</b> GBP 7.50
100, 125	<b>100.369.000</b> GBP 9.80
150	<b>100.370.000</b> GBP 11.80
200	<b>100.371.000</b> GBP 15.00
250	<b>80.690.000</b> GBP 18.30

4 plain partitions: 36E

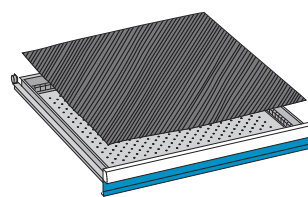

### Anti-slide mat

Designation	
Anti-slide mat anthracite	<b>100.394.000</b> GBP 6.00

Coating: special soft PVC foam.  
Extremely hardwearing and tear-proof.

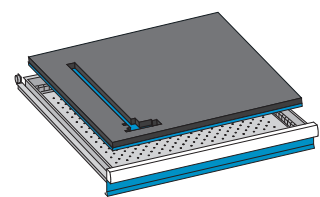

### PE plastic foam inserts

Designation	
Plastic foam insert, black. Thickness 25 mm	<b>80.918.000</b> GBP 20.30
Underlay blue. Thickness 5 mm	<b>80.907.000</b> GBP 13.00

Pre-cut inserts for the most popular tool sets on page 149.

## Substructures for workbenches Lista Premium

### Partition material 36 x 36E

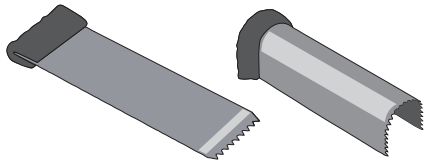

#### Plunge cutters

Designation	
Plunge cutter 20 mm	<b>80.920.000</b> GBP 2.60
Plunge cutter 50 mm	<b>80.921.000</b> GBP 4.80
Plunge cutter "U" 20 x 20 mm	<b>80.922.000</b> GBP 9.00
Plunge cutter for PE plastic foam inserts.	

#### Lista Script labels for partition material

Label size mm	Used for	Number	
47 x 18	Plastic boxes, clip-on label holders	2 sheets (A4), 52 labels each	<b>18.785.000</b> GBP 1.60
47 x 12	Plastic boxes, clip-on label holders	2 sheets (A4), 76 labels each	<b>18.786.000</b> GBP 1.60
27 x 12	Plastic boxes, clip-on label holders	2 sheets (A4), 133 labels each	<b>18.787.000</b> GBP 1.60

#### Lista Script labels for cabinet labelling

Label size mm	Used for	Number	
210 x 22 / 70 x 22	Drawer handle, drawer cabinet	5 sheets (A4), 10/30 labels each	<b>18.784.000</b> GBP 2.60

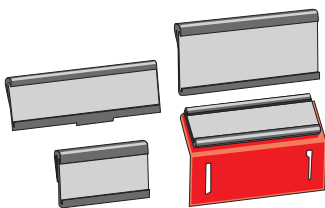

#### Clip-on label holders for partition material

Label size mm	Used for	Number	
27 x 12	Trough dividers, dividers, etc.	20 clip-on label holder, 266 labels	<b>134.029.000</b> GBP 7.30
47 x 12	Plastic boxes	20 label holders red	<b>134.034.000</b> GBP 6.80
47 x 12	Dividers, etc.	20 clip-on label holder, 152 labels	<b>134.049.000</b> GBP 7.30
47 x 18	Dividers, etc.	20 clip-on label holder, 104 labels	<b>134.052.000</b> GBP 7.30

# Substructures for workbenches Lista Premium

## Workbench drawer and storage shelf

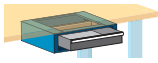

### Workbench drawer, width 578 mm, depth 725 mm

Useable drawer dimension: width 459 mm x depth 612 mm x height 129 mm.  
Load capacity 75 kg.

Height mm	Description	Workbench depth 750 mm	Workbench depth 800 mm
204	With cylinder lock	<b>43.246.XXX</b> GBP 180.00	<b>43.246.XXX</b> GBP 180.00

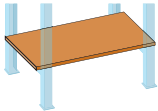

### Storage shelf between two/three workbench leg assemblies

Multiplex top, pre-drilled, incl. fastening materials.

Length mm	Depth mm	Thickness mm	Workbench depth 750 mm	Workbench depth 800 mm
1500	610	20	<b>43.247.000</b> GBP 60.00	<b>43.247.000</b> GBP 60.00
2000	610	20	<b>43.248.000</b> GBP 73.00	<b>43.248.000</b> GBP 73.00
2500	610	20	<b>43.258.000</b> GBP 90.00	<b>43.258.000</b> GBP 90.00
3000	610	20	<b>43.259.000</b> GBP 140.00	<b>43.259.000</b> GBP 140.00

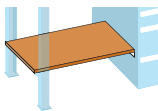

### Storage shelf between workbench leg assembly and drawer cabinet, width 564 mm, depth 725 mm (27 x 36E)

Multiplex top, pre-drilled, incl. fastening materials. Additional mounting bracket necessary.

Length mm	Depth mm	Thickness mm	Workbench depth 750 mm	Workbench depth 800 mm
1500	610	20	<b>43.266.000</b> GBP 58.00	<b>43.266.000</b> GBP 58.00
2000	610	20	<b>43.267.000</b> GBP 95.00	<b>43.267.000</b> GBP 95.00
2500	610	20	<b>43.271.000</b> GBP 100.00	<b>43.271.000</b> GBP 100.00
3000	610	20	<b>43.272.000</b> GBP 105.00	<b>43.272.000</b> GBP 105.00

### Mounting bracket for storage shelf

Designation	
Support bracket for storage shelves for drawer cabinet 27 x 36E	<b>43.273.000</b> GBP 6.00

### The Lista standard colours (without extra charge)

Please complete the last 3 digits of your product code (.XXX) with the desired colour code.

<b>.010</b>	<b>.020</b>	<b>.030</b>	<b>.040</b>	<b>.050</b>	<b>.060</b>	<b>.070</b>	<b>.080</b>	<b>.090</b>	<b>.100</b>
Light blue RAL 5012	Light grey RAL 7035	Reseda green RAL 6011	Capri blue RAL 5019	Grey metallic NCS S 6502-B	Black NCS S 9000-N	Ruby red RAL 3003	Pigeon grey NCS S 4502-B	Gentian blue RAL 5010	Signal blue RAL 5005

# Superstructures for workbenches Lista Premium

## Support pillars

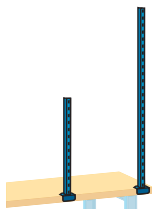

### Support pillars, load capacity 100 kg

The support pillars are screwed directly onto the top surface. Model: steel profile, perforated on the front and back, with 50-mm divisions for screwless attaching of expansion parts. Incl. fastening materials.

Height mm	
700	<b>44.000.XXX</b> GBP 30.00
1400	<b>44.001.XXX</b> GBP 43.00

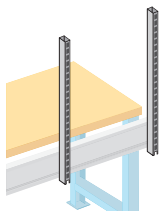

### Support pillars on stabilising profile, load capacity 100 kg

The support pillars are to be attached to the stabilisation profile. Two stabilisation profiles are necessary for the height 1400 mm. Support pillars on stabilisation profiles are only available for the workbench depth of 800 mm. Model: steel profile, perforated on the front and back, with 50-mm divisions for screwless attaching of expansion parts. Incl. fastening materials.

Height mm	Description	
700	Requires 1 stabilising profile	<b>44.002.XXX</b> GBP 45.00
1400	Requires 2 stabilising profiles	<b>44.003.XXX</b> GBP 85.00

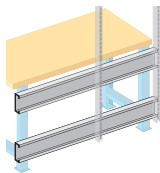

### Stabilising profile for support pillars

Excl. pre-assembly.

Width mm	
1500	<b>44.004.XXX</b> GBP 60.00
2000	<b>44.005.XXX</b> GBP 65.00
2500	<b>44.006.XXX</b> GBP 70.00
3000	<b>44.007.XXX</b> GBP 80.00

### Pre-assembly for stabilising profile

Designation	
Pre-assembly for stabilising profile	<b>88.442.000</b> GBP 11.00

### The Lista standard colours (without extra charge)

Please complete the last 3 digits of your product code (.XXX) with the desired colour code.

<b>.010</b>	<b>.020</b>	<b>.030</b>	<b>.040</b>	<b>.050</b>	<b>.060</b>	<b>.070</b>	<b>.080</b>	<b>.090</b>	<b>.100</b>
Light blue RAL 5012	Light grey RAL 7035	Reseda green RAL 6011	Capri blue RAL 5019	Grey metallic NCS S 6502-B	Black NCS S 9000-N	Ruby red RAL 3003	Pigeon grey NCS S 4502-B	Gentian blue RAL 5010	Signal blue RAL 5005

# Superstructures for workbenches Lista Premium

## Rear panels and keyhole hooks

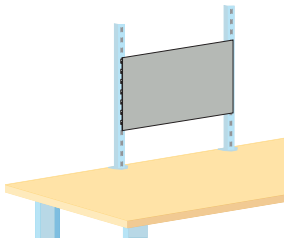

### Rear panels, plain

Width mm	Height mm	
750	100	<b>44.012.XXX</b> GBP 10.00
750	350	<b>44.013.XXX</b> GBP 18.00
1000	100	<b>44.014.XXX</b> GBP 15.00
1000	350	<b>44.015.XXX</b> GBP 23.00

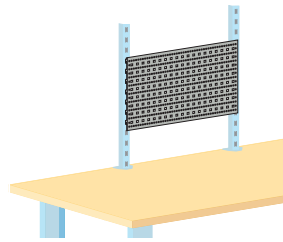

### Rear panels, perforated

Width mm	Height mm	
750	350	<b>44.016.XXX</b> GBP 28.00
1000	350	<b>44.017.XXX</b> GBP 33.00

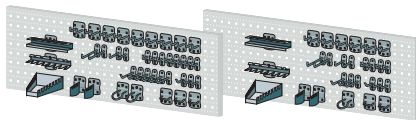

### Keyhole hook sets

Designation	
Hook set incl. 12 holders	<b>44.080.000</b> GBP 33.00
Hook set incl. 18 holders	<b>44.081.000</b> GBP 73.00
Hook set incl. 28 holders	<b>44.082.000</b> GBP 113.00
Hook set incl. 40 holders	<b>44.083.000</b> GBP 163.00

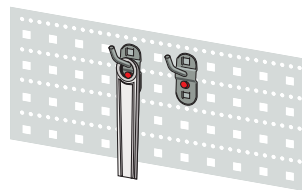

### Tool holder slanted

Length mm	Number	
50	5 pcs.	<b>44.084.000</b> GBP 8.00
100	5 pcs.	<b>44.085.000</b> GBP 9.00
150	5 pcs.	<b>44.086.000</b> GBP 10.00

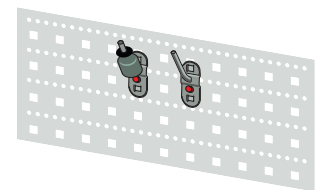

### Slanted hooks

Length mm	Number	
14/40	5 pcs.	<b>44.087.000</b> GBP 10.00

### The Lista standard colours (without extra charge)

Please complete the last 3 digits of your product code (.XXX) with the desired colour code.

<b>.010</b>	<b>.020</b>	<b>.030</b>	<b>.040</b>	<b>.050</b>	<b>.060</b>	<b>.070</b>	<b>.080</b>	<b>.090</b>	<b>.100</b>
Light blue RAL 5012	Light grey RAL 7035	Reseda green RAL 6011	Capri blue RAL 5019	Grey metallic NCS S 6502-B	Black NCS S 9000-N	Ruby red RAL 3003	Pigeon grey NCS S 4502-B	Gentian blue RAL 5010	Signal blue RAL 5005

# Superstructures for workbenches Lista Premium

## Rear panels and keyhole hooks

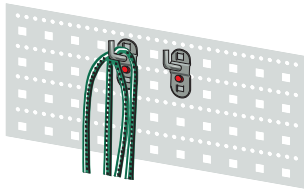

### Tool holder vertical, single

Length mm	Number	
35	5 pcs.	<b>44.088.000</b> GBP 8.00
75	5 pcs.	<b>44.089.000</b> GBP 9.00
125	5 pcs.	<b>44.092.000</b> GBP 10.00

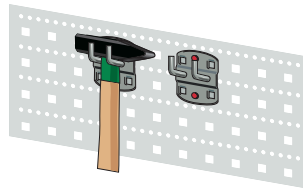

### Tool holder vertical, double

Length mm	Number	
35	5 pcs.	<b>44.106.000</b> GBP 16.30
50	5 pcs.	<b>44.107.000</b> GBP 17.00
75	5 pcs.	<b>44.108.000</b> GBP 17.80

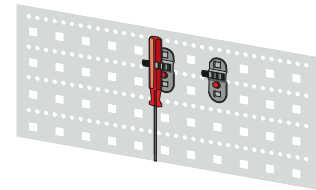

### Tool clamp

Diameter mm	Number	
6	5 pcs.	<b>44.098.000</b> GBP 12.50
10	5 pcs.	<b>44.099.000</b> GBP 12.80
13	5 pcs.	<b>44.101.000</b> GBP 13.00
16	5 pcs.	<b>44.102.000</b> GBP 13.30
19	5 pcs.	<b>44.105.000</b> GBP 13.50

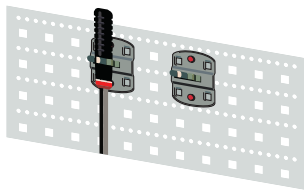

### Tool clamp, large base top

Diameter mm	Number	
25	5 pcs.	<b>44.109.000</b> GBP 21.30
28	5 pcs.	<b>44.110.000</b> GBP 25.00
32	5 pcs.	<b>44.111.000</b> GBP 28.80

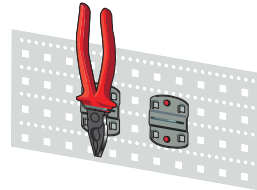

### Pliers holder

Width mm	Number	
35	5 pcs.	<b>44.119.000</b> GBP 17.50
55	5 pcs.	<b>44.120.000</b> GBP 18.80
75	5 pcs.	<b>44.121.000</b> GBP 20.00

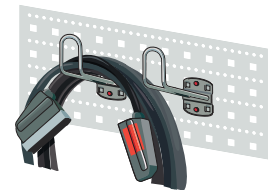

### Cable holder

Length mm	Number	
150	5 pcs.	<b>44.123.000</b> GBP 37.50

# Superstructures for workbenches Lista Premium

## Rear panels and keyhole hooks

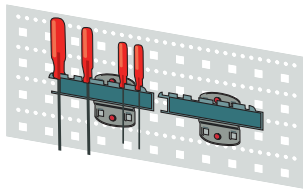

### Screwdriver holder

Description	Number	Price
For 6 parts	2	<b>44.124.000</b> GBP 10.00

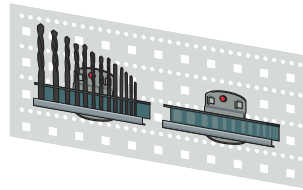

### Drill bit and hex socket holder

Description	Number	Price
For 14 parts	2	<b>44.125.000</b> GBP 11.50

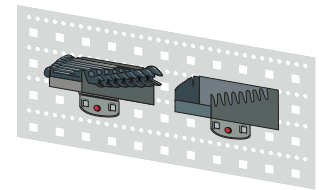

### Spanner holder

Description	Number	Price
For 8 pieces	2	<b>44.126.000</b> GBP 11.50

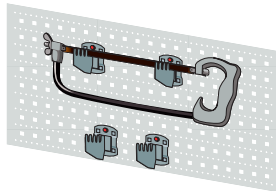

### Saw holder

Description	Number	Price
For 4 saws	2 pcs.	<b>44.127.000</b> GBP 14.00

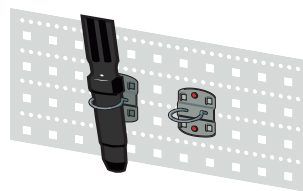

### Machine holder

Diameter mm	Number	Price
40	5 pcs.	<b>44.128.000</b> GBP 31.30

# Superstructures for workbenches Lista Premium

## Adjustable shelves

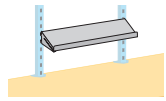

### Adjustable shelves, load capacity 25 kg

All shelves can be hung onto the support pillars without screws. Slotted execution. Slots are 15 mm apart, allowing for division with partitions.

Width mm	Depth mm	Description	
750	300	plain	<b>44.027.XXX</b> GBP 25.00
750	350	plain	<b>44.033.XXX</b> GBP 30.00
1000	300	plain	<b>44.034.XXX</b> GBP 30.00
1000	350	plain	<b>44.035.XXX</b> GBP 33.00
750	300	slotted	<b>44.036.XXX</b> GBP 33.00
750	350	slotted	<b>44.037.XXX</b> GBP 35.00
1000	300	slotted	<b>44.039.XXX</b> GBP 35.00
1000	350	slotted	<b>44.040.XXX</b> GBP 40.00

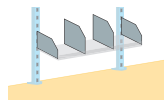

### Dividing walls for adjustable shelves, slotted

For dividing up slotted shelves. Model: sheet steel. Colour: light grey RAL 7035.

Width mm	Height mm	
300	95	<b>100.447.000</b> GBP 3.00
300	145	<b>100.448.000</b> GBP 3.00
300	195	<b>100.449.000</b> GBP 4.00
350	95	<b>100.452.000</b> GBP 3.00
350	145	<b>100.453.000</b> GBP 3.00
350	195	<b>100.454.000</b> GBP 4.00

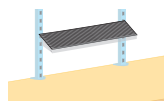

### Rubber ribbed mats for adjustable shelves

Slip-resistant rubber ribbed mat for shelf. Colour: grey.

Width mm	Depth mm	
750	300	<b>44.054.000</b> GBP 30.00
750	350	<b>44.055.000</b> GBP 35.00
1000	300	<b>44.056.000</b> GBP 35.00
1000	350	<b>44.057.000</b> GBP 40.00

### The Lista standard colours (without extra charge)

Please complete the last 3 digits of your product code (.XXX) with the desired colour code.

<b>.010</b>	<b>.020</b>	<b>.030</b>	<b>.040</b>	<b>.050</b>	<b>.060</b>	<b>.070</b>	<b>.080</b>	<b>.090</b>	<b>.100</b>
Light blue RAL 5012	Light grey RAL 7035	Reseda green RAL 6011	Capri blue RAL 5019	Grey metallic NCS S 6502-B	Black NCS S 9000-N	Ruby red RAL 3003	Pigeon grey NCS S 4502-B	Gentian blue RAL 5010	Signal blue RAL 5005

# Superstructures for workbenches Lista Premium

## Container strip mountings

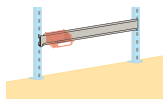

### Container strips

For holding storage containers size 2, 3 and 4; can be hung on the support pillars without screws. Model: sheet steel.

Width mm	Height mm	Description	
750	85	For container sizes 2, 3 and 4	<b>44.041.XXX</b> GBP 13.00
1000	85	For container sizes 2, 3 and 4	<b>44.042.XXX</b> GBP 15.00

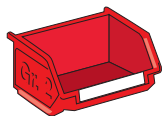

### Storage containers for container strips

Polyethylene, for hanging on the container strip mountings.

Width mm	Depth mm	Height mm	Description	
103	93	52	Size 2, red	<b>80.737.000</b> GBP 1.00
103	93	52	Size 2, green	<b>80.738.000</b> GBP 1.00
103	93	52	Size 2, blue	<b>80.728.000</b> GBP 1.00
103	93	52	Size 2, yellow	<b>80.768.000</b> GBP 1.00
103	168	76	Size 3, red	<b>80.733.000</b> GBP 2.00
103	168	76	Size 3, green	<b>80.724.000</b> GBP 2.00
103	168	76	Size 3, blue	<b>80.729.000</b> GBP 2.00
103	168	76	Size 3, yellow	<b>80.702.000</b> GBP 2.00
149	233	121	Size 4, red	<b>80.734.000</b> GBP 4.00
149	233	121	Size 4, green	<b>80.725.000</b> GBP 4.00
149	233	121	Size 4, blue	<b>80.730.000</b> GBP 4.00
149	233	121	Size 4, yellow	<b>80.721.000</b> GBP 4.00

### Accessories for storage containers

Designation	Description	Number	
Labelling strips	For size 2	10 pcs.	<b>80.739.000</b> GBP 0.80
Transparent film	For size 2	10 pcs.	<b>80.740.000</b> GBP 1.30
Labelling strips	For size 3	10 pcs.	<b>80.741.000</b> GBP 0.80
Transparent film	For size 3	10 pcs.	<b>80.742.000</b> GBP 1.30
Labelling strips	For size 4	10 pcs.	<b>88.105.000</b> GBP 0.80
Transparent film	For size 4	10 pcs.	<b>88.106.000</b> GBP 1.30

### The Lista standard colours (without extra charge)

Please complete the last 3 digits of your product code (.XXX) with the desired colour code.

<b>.010</b>	<b>.020</b>	<b>.030</b>	<b>.040</b>	<b>.050</b>	<b>.060</b>	<b>.070</b>	<b>.080</b>	<b>.090</b>	<b>.100</b>
Light blue RAL 5012	Light grey RAL 7035	Reseda green RAL 6011	Capri blue RAL 5019	Grey metallic NCS S 6502-B	Black NCS S 9000-N	Ruby red RAL 3003	Pigeon grey NCS S 4502-B	Gentian blue RAL 5010	Signal blue RAL 5005

# Superstructures for workbenches Lista Premium

## Shelves with raised edging and vice

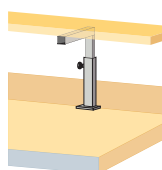

### Shelves with raised edging

MDF board with three-sided (back and sides) 8 mm protruding raised beech edge, with colourless priming on all sides.

Length mm	Depth mm	Description	
1500	300	Requires 2 brackets	<b>44.043.000</b> GBP 33.00
2000	300	Requires 3 brackets	<b>44.044.000</b> GBP 40.00
2500	300	Requires 3 brackets	<b>44.045.000</b> GBP 47.00
3000	300	Requires 4 brackets	<b>44.046.000</b> GBP 54.00

### Height-adjustable brackets

The brackets allow adjustment of the shelf with raised edging at four different heights. They are screwed through the workbench surface. Model: made of rectangular steel tubing, incl. fastening materials. Colour: light grey RAL 7035.

Description	
Adjustment heights 230, 270, 310, 350 mm	<b>44.047.000</b> GBP 25.00
Pre-assembly for bracket	<b>39.208.000</b> GBP 10.00

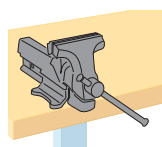

### Vice, Heuer system

The pre-assembly includes cut-out holes.

Description	
Type 100 – 120, max. opening = 150 mm, jaw width = 120 mm	<b>44.059.000</b> GBP 160.00
Type 100 – 140, max. opening = 200 mm, jaw width = 140 mm	<b>44.060.000</b> GBP 225.00
Pre-assembly vice left	<b>44.131.000</b> GBP 14.00
Pre-assembly vice middle	<b>44.132.000</b> GBP 14.00
Pre-assembly vice right	<b>44.133.000</b> GBP 14.00

## Partition material as separate components

### Order with a system

Partition materials which we offer for Lista Premium drawer cabinets are available as complete sets and may be found in this catalogue with every drawer size. If these sets don't satisfy your requirements you can also order components separately.

#### Best flexibility

Through custom division of each individual drawer you achieve optimum use of space. The grid used with Lista drawers is the same for all cabinet types. The basic dimension is the unit 17 mm, which corresponds to the distance from slot to slot. Our partition materials are based on this basic dimension.

Using the groundbreaking, efficient labelling system, Lista Script, you can have your drawers and individual divisions labelled perfectly and individually.



Lista partition materials create order with a system. For all business areas and every need.

#### Coordination to the drawer height

When selecting partition materials, care must be taken in each case that the height matches the drawer. For this, the front height of the drawer, for which the partition materials are suitable, is indicated in the selection tables.

# Individual partition material Lista Premium

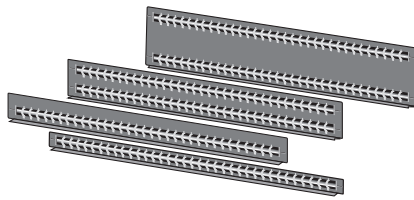

## Slotted partitions

Description	For front height 50 mm	For front height 75 mm	For front height 100, 125 mm	For front height 150 mm	For front height 200 mm	For front height 250 mm	For front height 300 mm
Length 304 mm (18E)	<b>12.015.000</b> GBP 2.50	<b>12.124.000</b> GBP 3.10	<b>12.016.000</b> GBP 3.80	<b>12.017.000</b> GBP 4.70	<b>12.125.000</b> GBP 6.00		<b>12.018.000</b> GBP 7.50
Length 456 mm (27E)	<b>80.085.000</b> GBP 2.60	<b>80.089.000</b> GBP 2.80	<b>80.095.000</b> GBP 3.90	<b>80.101.000</b> GBP 4.90	<b>80.107.000</b> GBP 6.00	<b>80.220.000</b> GBP 7.00	<b>80.111.000</b> GBP 7.80
Length 610 mm (36E)	<b>80.088.000</b> GBP 2.70	<b>80.091.000</b> GBP 3.00	<b>80.097.000</b> GBP 4.10	<b>80.103.000</b> GBP 5.30	<b>80.108.000</b> GBP 6.00	<b>80.221.000</b> GBP 7.30	<b>80.112.000</b> GBP 8.00

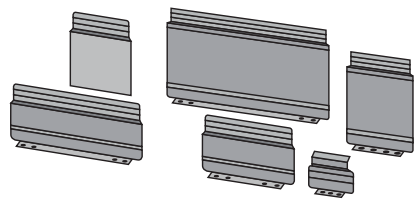

## Dividers for slotted partitions

Description	For front height 50 mm	For front height 75 mm	For front height 100, 125 mm	For front height 150 mm	For front height 200 mm	For front height 250 mm	For front height 300 mm
Length 31 mm (2E)	<b>100.836.000</b> GBP 0.40						
Length 48 mm (3E)	<b>100.837.000</b> GBP 0.40	<b>100.848.000</b> GBP 0.50	<b>100.859.000</b> GBP 0.60				
Length 65 mm (4E)	<b>100.838.000</b> GBP 0.50	<b>100.849.000</b> GBP 0.50	<b>100.860.000</b> GBP 0.60				
Length 82 mm (5E)	<b>100.839.000</b> GBP 0.50	<b>100.850.000</b> GBP 0.60	<b>100.861.000</b> GBP 0.70				
Length 98 mm (6E)	<b>100.840.000</b> GBP 0.50	<b>100.851.000</b> GBP 0.60	<b>100.862.000</b> GBP 0.70	<b>100.870.000</b> GBP 0.80			
Length 116 mm (7E)	<b>100.841.000</b> GBP 0.60	<b>100.852.000</b> GBP 0.70	<b>100.863.000</b> GBP 0.80	<b>100.871.000</b> GBP 0.80	<b>100.982.000</b> GBP 0.90		
Length 133 mm (8E)	<b>100.842.000</b> GBP 0.60	<b>100.853.000</b> GBP 0.70	<b>100.864.000</b> GBP 0.80	<b>100.872.000</b> GBP 0.90	<b>100.878.000</b> GBP 1.00	<b>123.447.000</b> GBP 1.30	
Length 149 mm (9E)	<b>100.843.000</b> GBP 0.70	<b>100.854.000</b> GBP 0.80	<b>100.865.000</b> GBP 0.90	<b>100.873.000</b> GBP 1.00	<b>100.879.000</b> GBP 1.20	<b>123.448.000</b> GBP 1.50	<b>100.884.000</b> GBP 1.90
Length 167 mm (10E)	<b>100.844.000</b> GBP 0.70	<b>100.855.000</b> GBP 0.80	<b>100.866.000</b> GBP 0.90	<b>100.874.000</b> GBP 1.00	<b>100.880.000</b> GBP 1.40	<b>123.449.000</b> GBP 1.80	<b>100.885.000</b> GBP 2.10
Length 201 mm (12E)	<b>100.845.000</b> GBP 0.80	<b>100.856.000</b> GBP 0.90	<b>100.867.000</b> GBP 1.00	<b>100.875.000</b> GBP 1.10	<b>100.881.000</b> GBP 1.70	<b>123.451.000</b> GBP 2.20	<b>100.886.000</b> GBP 2.50
Length 252 mm (15E)	<b>100.846.000</b> GBP 0.90	<b>100.857.000</b> GBP 1.00	<b>100.868.000</b> GBP 1.00	<b>100.876.000</b> GBP 1.30	<b>100.882.000</b> GBP 1.90	<b>123.454.000</b> GBP 2.40	<b>100.887.000</b> GBP 2.80
Length 303 mm (18E)	<b>100.847.000</b> GBP 1.00	<b>100.858.000</b> GBP 1.00	<b>100.869.000</b> GBP 1.10	<b>100.877.000</b> GBP 1.60	<b>100.883.000</b> GBP 2.20	<b>123.457.000</b> GBP 2.60	<b>100.888.000</b> GBP 3.10

# Individual partition material Lista Premium

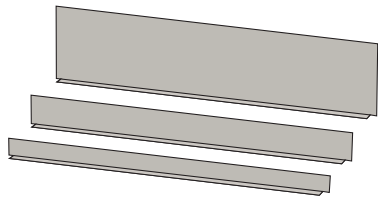

## Dividers

Description	For front height 50 mm	For front height 75 mm	For front height 100, 125 mm	For front height 150 mm	For front height 200 mm	For front height 250 mm	For front height 300 mm
Length 304 mm (18E)	<b>12.088.000</b> GBP 1.40	<b>12.121.000</b> GBP 1.70	<b>12.089.000</b> GBP 1.90	<b>12.090.000</b> GBP 2.50	<b>12.122.000</b> GBP 3.20		<b>12.091.000</b> GBP 4.40
Length 456 mm (27E)	<b>80.237.000</b> GBP 1.60	<b>80.121.000</b> GBP 1.80	<b>80.127.000</b> GBP 2.30	<b>80.133.000</b> GBP 2.80	<b>80.139.000</b> GBP 3.60	<b>80.222.000</b> GBP 4.30	
Length 610 mm (36E)	<b>80.239.000</b> GBP 2.30	<b>80.123.000</b> GBP 2.30	<b>80.129.000</b> GBP 2.50	<b>80.135.000</b> GBP 2.90	<b>80.141.000</b> GBP 3.80	<b>80.225.000</b> GBP 4.60	<b>80.144.000</b> GBP 5.50
Length 762 mm (45E)	<b>80.541.000</b> GBP 2.50	<b>80.542.000</b> GBP 3.00	<b>80.543.000</b> GBP 3.50	<b>80.544.000</b> GBP 4.50	<b>80.545.000</b> GBP 6.00	<b>80.546.000</b> GBP 9.00	<b>80.547.000</b> GBP 9.30
Length 915 mm (54E)	<b>80.178.000</b> GBP 3.10	<b>80.179.000</b> GBP 3.50	<b>80.180.000</b> GBP 3.90	<b>80.181.000</b> GBP 4.80	<b>80.182.000</b> GBP 6.50	<b>80.183.000</b> GBP 8.80	<b>80.184.000</b> GBP 10.90
Length 1085 mm (64E)		<b>80.124.000</b> GBP 4.20	<b>80.130.000</b> GBP 4.70	<b>80.136.000</b> GBP 7.00	<b>80.142.000</b> GBP 7.50	<b>80.228.000</b> GBP 10.80	<b>80.229.000</b> GBP 11.00
Length 1323 mm (78E)		<b>80.125.000</b> GBP 4.90	<b>80.131.000</b> GBP 5.50	<b>80.137.000</b> GBP 6.50	<b>80.143.000</b> GBP 11.00	<b>80.685.000</b> GBP 12.50	<b>80.233.000</b> GBP 14.00

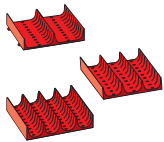

## Trough-shaped parts 153 mm (9E) x 153 mm (9E) x 27 mm

Description	
2 troughs	<b>100.156.000</b> GBP 1.70
3 troughs	<b>100.157.000</b> GBP 1.80
4 troughs	<b>100.158.000</b> GBP 1.90



## Trough dividers

Description	Number	
For 2 troughs	10 pcs.	<b>134.020.000</b> GBP 2.20
For 3 troughs	10 pcs.	<b>134.040.000</b> GBP 2.20
For 4 troughs	10 pcs.	<b>134.044.000</b> GBP 2.20

## Individual partition material Lista Premium

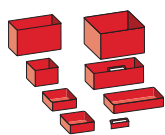

### Plastic boxes

Height mm	Depth mm	Width mm	Description	For front height 50 mm	For front height 75 mm	For front height 100, 125 mm
26	75	75	With fixed centre partition	<b>100.073.000</b> GBP 0.80		
26	75	75		<b>100.077.000</b> GBP 0.80		
26	75	150		<b>100.079.000</b> GBP 0.90		
26	150	150		<b>100.075.000</b> GBP 1.60		
46	75	75			<b>100.076.000</b> GBP 0.90	
46	75	150			<b>100.078.000</b> GBP 1.20	
46	100	50	With single parti- tion possibility 1x		<b>146.202.000</b> GBP 0.90	
46	150	150		<b>100.074.000</b> GBP 1.90		
71	75	150				<b>100.081.000</b> GBP 2.10
71	150	150				<b>100.080.000</b> GBP 2.40

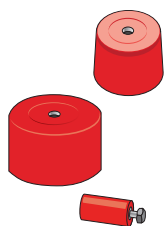

### Milling cutter holders

Diameter mm	Height mm	Number	
12.2	26	10 pcs.	<b>100.096.000</b> GBP 10.00
15.5	26	10 pcs.	<b>100.097.000</b> GBP 10.00
21.5	26	10 pcs.	<b>100.098.000</b> GBP 10.00
25	26	5 pcs.	<b>100.103.000</b> GBP 10.00
26.5	26	5 pcs.	<b>100.099.000</b> GBP 10.00
31.2	26	5 pcs.	<b>100.100.000</b> GBP 10.00
37.5	26	5 pcs.	<b>100.104.000</b> GBP 10.00
39.5	26	5 pcs.	<b>100.101.000</b> GBP 10.00
49.5	26	5 pcs.	<b>100.102.000</b> GBP 10.00

# Individual partition material Lista Premium



## PE plastic foam module inserts

### Description

149 x 300 mm (9 x 18E)

**80.926.000**  
GBP 12.30

Foam module insert for Allen keys  
1.5–10

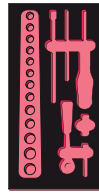

## PE plastic foam module inserts

### Description

149 x 300 mm (9 x 18E)

**80.927.000**  
GBP 14.30

Foam module insert for socket  
wrenches ¼ inch



## PE plastic foam module inserts

### Description

300 x 300 mm (18 x 18E)

**80.928.000**  
GBP 17.30

Foam module insert for ring and  
flat spanners 6–24

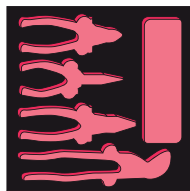

## PE plastic foam module inserts

### Description

300 x 300 mm (18 x 18E)

**80.929.000**  
GBP 14.80

Foam module insert for pliers:  
– universal pliers 180  
– telephone pliers 160  
– side-cutting pliers 160  
– multigrip pliers 240

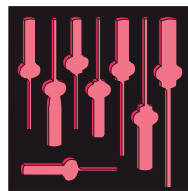

## PE plastic foam module inserts

### Description

300 x 300 mm (18 x 18E)

**80.930.000**  
GBP 16.80

Foam module insert for screw-  
drivers:  
⊖5–1, ⊕0–60 / 1–80 / 2–200

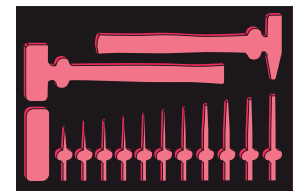

## PE plastic foam module inserts

### Description

300 x 447 mm (18 x 27E)

**80.931.000**  
GBP 20.30

Foam module insert for striking  
tools:  
– ball-peen hammer 300 g  
– nylon hammer ø 4/35  
– punches 1–9, incl. centre  
punch size 1+2

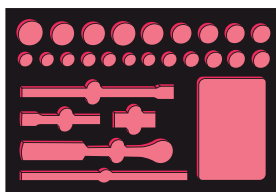

## PE plastic foam module inserts

### Description

300 x 447 mm (18 x 27E)

**80.932.000**  
GBP 22.30

Foam module insert for socket  
wrenches ½ inch

## Individual partition material Lista Premium

### Lista Script labels for partition material

Label size mm	Used for	Number	
47 x 18	Plastic boxes, clip-on label holders	2 sheets (A4), 52 labels each	<b>18.785.000</b> GBP 1.60
47 x 12	Plastic boxes, clip-on label holders	2 sheets (A4), 76 labels each	<b>18.786.000</b> GBP 1.60
27 x 12	Plastic boxes, clip-on label holders	2 sheets (A4), 133 labels each	<b>18.787.000</b> GBP 1.60

### Lista Script labels for cabinet labelling

Label size mm	Used for	Number	
210 x 22 / 70 x 22	Drawer handle, drawer cabinet	5 sheets (A4), 10/30 labels each	<b>18.784.000</b> GBP 2.60

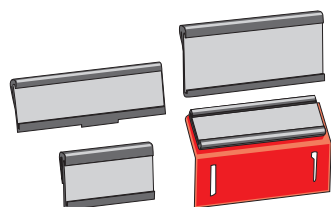

### Clip-on label holders for partition material

Label size mm	Used for	Number	
27 x 12	Trough dividers, dividers, etc.	20 clip-on label holder, 266 labels	<b>134.029.000</b> GBP 7.30
47 x 12	Plastic boxes	20 label holders red	<b>134.034.000</b> GBP 6.80
47 x 12	Dividers, etc.	20 clip-on label holder, 152 labels	<b>134.049.000</b> GBP 7.30
47 x 18	Dividers, etc.	20 clip-on label holder, 104 labels	<b>134.052.000</b> GBP 7.30

Subject to modifications

Prices excluding VAT

Terms of delivery:  
ex works Erlen (CH)

Edition 2008, June

Lista AG  
Fabrikstrasse 1  
CH-8586 Erlen

Telephone +41 71 649 21 11  
Telefax +41 71 649 22 03  
info@lista.com  
www.lista.com

### **Lista Premium 75/200**

Lista Premium, the top Lista product line with the carrying capacity classes 75 kg and 200 kg, allows you to freely configure drawer cabinets and workbenches made from a variety of elements and colours. Each product is custom-made for you.

Your Lista partner:

---